

SCREEN CREATOR 5
User's Manual
Vol.2

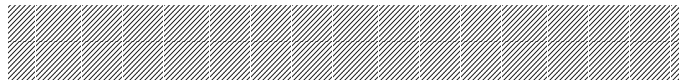

SCREEN CREATOR 5

OPERATIONS

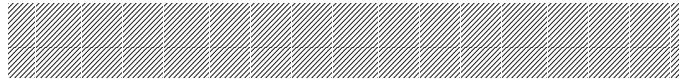

KOMATSU

Electronic System & Component Dept.
Electronics Div.

Contents

CHAPTER 1 FUNDAMENTALS IN CREATING SCREENS

1-1	Screen Creator 5	1-2
1-2	Project	1-3
1-3	Screen	1-4
	(1) Local and global screens.....	1-4
	(2) Screen configuration	1-6
1-4	Component.....	1-7
	(1) Component configuration	1-7
	(2) Component attributes	1-8
	(3) Group components.....	1-9
1-5	Control.....	1-10
	(1) Control types	1-10
	(2) Control overlapping	1-10
	(3) Action parameter for control	1-11
1-6	Library.....	1-12
	(1) Standard components	1-12
	(2) Recorded character string	1-12
	(3) Texture.....	1-13
	(4) Bit map.....	1-13
1-7	System Timer.....	1-14
1-8	Colors	1-15
	(1) Colors used in Screen Creator 5	1-15
	(2) Transparent.....	1-15
	(3) Basic color in an area.....	1-15
1-9	Downloading	1-16

(1) Recording 1-16

CHAPTER 2 INSTALLATION OF SCREEN CREATOR 5

2-1 Operation Environment 2-2

2-2 Install Screen Creator 5..... 2-3

2-3 File Configuration after Installation 2-4

2-4 Start Screen Creator 5 2-5

2-5 Uninstall Screen Creator 5 2-6

CHAPTER 3 BASIC OPERATIONS FOR SCREEN CREATOR 5

3-1 Components and Functions of Screen Creator 5 3-2

 (1) Names and functions 3-2

 (2) Tool bar..... 3-6

3-2 Basic Operations for Mouse and Keyboard 3-12

 (1) Create an element of a screen or component (drawing) 3-12

 (2) Create a component on a screen (arrangement) 3-14

 (3) Create a control to a component..... 3-14

 (4) Edit a created entity (drawing element, component, and control) with a command..... 3-15

 (5) Edit a created entity (drawing element, component, and control) with a handle..... 3-16

 (6) Change component area..... 3-16

3-3 Basic Operation for Downloading 3-17

CHAPTER 4 MENU REFERENCE

4-1 Screen (S) 4-2

 (1) Create (N) 4-2

 (2) Open (O)..... 4-2

 (3) Close (C)..... 4-3

 (4) Save (S)..... 4-3

 (5) Delete a screen (D)..... 4-4

(6) Close arranged components (H)	4-5
(7) Save arranged components (R)	4-5
(8) Screen/components properties (P).....	4-5
(9) Documentation on screen/arranged components (L)	4-6
(10) Exit from an application (X)	4-8
4-2 Create (D).....	4-9
(1) Select mode (D)	4-9
(2) Line (L).....	4-9
(3) Arc (A).....	4-10
(4) Continuous line (V).....	4-12
(5) Spline (W)	4-14
(6) Rectangle (R)	4-15
(7) Parallelogram (Q).....	4-17
(8) Circle/ellipse (E)	4-18
(9) Paint (F)	4-19
(10) Characters (S).....	4-20
(11) Bit map (B)	4-22
(12) Texture (T)	4-23
(13) Macro (M).....	4-25
(14) Control (C).....	4-29
(15) Components (P).....	4-29
4-3 Editing (E) — At Drawing —.....	4-32
(1) Undo (U).....	4-32
(2) Redo (W).....	4-32
(3) Cut (T).....	4-32
(4) Copy (C).....	4-32
(5) Paste (P)	4-32
(6) Delete (D).....	4-32
(7) Select all (A).....	4-32
(8) Redisplay (D).....	4-33
(9) Edit vertex (Z).....	4-33
(10) Change attributes/properties (E)	4-34
(11) Edit component contents (H).....	4-35
(12) Change order (O)	4-36
(13) Rotation/mirror (M)	4-37
(14) Group components (G).....	4-38

(15) Roll out a texture (S)	4-39
(16) Edit a screen (component) program (B).....	4-39
(17) Edit an action parameter (V)	4-39
4-4 Editing (E) — At Writing a Program —.....	4-40
(1) Undo (U)	4-40
(2) Cut (T).....	4-40
(3) Copy (C)	4-40
(4) Paste (P).....	4-40
(5) Delete (D)	4-40
(6) Select all (A)	4-40
(7) Find (F)	4-41
(8) Replace (E).....	4-42
(9) Jump to the top (S)	4-43
(10) Jump to the last (L)	4-43
(11) Function library (X).....	4-44
4-5 Library (L).....	4-46
(1) Create (N)	4-46
(2) Open (O).....	4-46
(3) Close (C).....	4-47
(4) Save (S).....	4-48
(5) Library member properties (P)	4-49
(6) Documentation on library member (L).....	4-50
(7) Add a component from a screen (V)	4-51
(8) Add a new outside file (A)	4-52
(9) Maintenance (M).....	4-55
4-6 Tool (T).....	4-59
(1) Display (V)	4-59
(2) Option (O)	4-61
(3) List browse (B)	4-63
(4) Confirm display (L).....	4-64
(5) Restore data for the conventional model (R).....	4-65
(6) Numeric input browse (N)	4-67
4-7 Window (W).....	4-68
(1) Pile up display (C).....	4-68

(2) Cascade display (H)	4-68
(3) Display right-left (T)	4-68
(4) Adjust object size (O)	4-68
(5) Align icons (A)	4-68
4-8 Project (P).....	4-69
(1) Create (N)	4-69
(2) Open (O)	4-71
(3) Close (C)	4-72
(4) Project properties (P)	4-72
(5) Documentation on project (L)	4-72
(6) Record (R).....	4-74
(7) Downloading (D).....	4-76
(8) Uploading (U)	4-78
(9) Create a character string (S)	4-83
(10) Edit a device (M)	4-86
(11) Backup (B)	4-88
(12) Restore (A).....	4-89
(13) Copy (Y)	4-89
(14) Delete (E)	4-90

How This Manual Is Organized

This manual, Chapter 1 through 4, includes structures of data to be displayed on the OIP and operations in detail for you to use the OIP.

Chapter 1 Fundamentals in Creating Screens

Outlines general ideas and organizations of data to be displayed on the OIP. You should read through this chapter before referencing the other chapters.

Chapter 2 Installation for Screen Creator 5

Covers the environment in operation and installation of Screen Creator 5.

Chapter 3 Basic Operations for Screen Creator 5

Describes each function name of Screen Creator 5 and operations for the keyboard and mouse.

Chapter 4 Menu Reference

Thoroughly discusses each menu of Screen Creator 5.

You are recommended to reference the following manuals for using Screen Creator 5.

Vol.1 Screen Creator 5 Manual Introduction

Introduces fundamental operations of Screen Creator 5.

Vol.2 Screen Creator 5 Manual Operations

Describes operations of Screen Creator 5 in details.

Vol. 3 Screen Creator 5 Manual PLC/External Equipment Connection

Covers the communications procedures with a host computer and connections to peripheral devices.

Vol. 4 Screen Creator 5 Manual Standard Component Catalog

You can get to know the standard components and their functions the Komatsu Ltd. offers.

Vol. 5 Screen Creator 5 Manual Control Reference

Describes what are controls and how to use controls for creating components.

Vol. 6 Screen Creator 5 Manual K-Basic Programming

Offers information on how to write action programs for creating screens and how to use functions.

Vol. 7 Screen Creator 5 Manual Trouble Shooting and Error Codes

Covers restrictions on creating screens with Screen Creator 5, how to cope with trouble, and error codes.

Safety Precautions

Be sure to follow the safety precautions listed below in order to use the OIP safely. Komatsu Ltd. cannot be held liable for any damages incurred if these safety precautions are not followed.



WARNING

- Design your system so that there are sufficient countermeasures for personnel accidents and major equipment accidents. The system should have an external protection and safety circuit, so that even if the OIP should malfunction or even if there is a defect in the program the safety of the system is assured.
- Do not use the touch panel of the OIP to make switches that are related to safety or people or major damages (emergency safety switches, etc.). Be sure that the system is designed so that it can cope with any errors or malfunctions in the touch panel.
- Be sure that type 3 grounding is used for the protective-grounding terminal. There is a possibility of electrical shock if the unit is not grounded.
- If the OIP should malfunction, immediately turn off the poser and leave it alone.
- If there is direct output to external output device such as PLCs, direct output will be driven regardless of the ladder circuit interlock. Output may be used to drive motors and the like, so avoid using direct output because it is dangerous.



CAUTION

- Use and store the OIP in the environment described in the specifications (regarding vibration, shock, temperature, humidity, etc.).
- Do not use the OIP where it is subjected to inflammable or explosive gas, or steam.
- Before turning on the power, be sure that the power voltage rating of the OIP and the voltage rating power supply match. Using a mistaken power supply can damage the unit.
- Do not disassemble or modify the OIP. Doing so can cause malfunctions and lead to other problems.
- The OIP touch panel is made of glass. Striking it with hard objects or pressing hard on it may break the glass.
- Do not push down on the OIP touch panel with mechanical pencils, screwdrivers, or other sharp objects. Doing so can damage the touch panel or cause malfunctions.

Notations Used In This Manual

This manual uses the following symbol marks for you to use this system comfortably.



WARNING

Describes a peril that may cause operator's death or serious injury in neglecting the WARNING item(s).



Caution

Describes a peril that may cause bodily injury or serious device damage in neglecting the CAUTION item(s).



Describes general note(s) in use.

Note)

Explanations and supplements.

Glossaries used in this manual are as follows.

OIP

Stands for Advanced Intelligent Panel.

PLC

Stands for programmable controller. It is also called a sequence controller.

Link unit

A link unit is a communication equipment which connects this equipment and the PLC. The nomenclature of the communication equipment is different from each manufacture and the equipment is called a link unit in general.

Device

A device is such equipment that an input/output relay, internal relay, timer, counter, or resister in the PLC.

Notice

We have used our best efforts in preparing this manual. We make no warranties with respect to the accuracy, or completeness of the contents of this manual and purpose. We shall not be liable any loss of profit or any other commercial damages, applying this manual directly and indirectly.

- 1) All rights reserved. No part of this book may be reproduced in any form or by any means, without permission in writing from Komatsu Ltd.
- 2) Contents of this manual shall be subject to change without notice.
- 3) While every precaution has been taken in the preparation of this manual, if the reader notice any errors or has any advice on the contents of this manual, please contact our customer support in Sales Division of Komatsu Ltd.
- 4) We shall have no liability to any loss or damage caused or alleged to be caused directly or indirectly by the statements contained in this manual or by the computer software and hardware products described in it.
- 5) Komatsu Ltd. may have patents or pending patent applications, copyrights, or other intellectual property rights covering subject matter in this manual. The furnishing of this manual does not give you any license to these patents or other intellectual property rights. And we do not have any responsibility on troubles involved in the patents and other intellectual rights caused by the use of this manual.
- 6) Contact us at the following place concerning other unclear points in this manual.

**Customer Support Group
Sales Department
Electronics System Division
Komatsu Ltd.**

Address: 4-20-1, Kamata, Ota-ku, Tokyo Japan

Telephone: 81-03-5711-1838

Facsimile: 81-03-5711-1840

Version Up

Komatsu Ltd. has upgraded Screen Creator 5 for adding new functions, operationability and so forth. Below will be introduced the updated functions.

1. Version 2.10

- Supporting middle size systems (GC53) of GC5x Series
- Adding the uploading editing function

To make this function effective, attach all screen data and K-Basic programs used in the project and download them to the panel. Then download the uploaded entities from the panel and restore them. Then you can edit the data and programs. Note that the data with the project attached increase their size.

- The following PLCs have been added.

Omron	SYSMAC α
Fuji Denki	FLEX-PC NJ-T/NS-T
Fuji Denki	Computer-link protocol
Fuji Denki	Loader command protocol
Toyota Koki	PC1
Toyota Koki	PC3
Matsushita Electric Industry	Panadac 7000

- Standard components, centered on the parts used for middle size systems (GC53) in the GC5x Series have drastically been added.

CHAPTER 1

FUNDAMENTALS IN CREATING SCREENS

1-1 Screen Creator 5

Explanation

Screen Mate 5 is a piece of software that creates screens to be displayed on the OIP with a personal computer. This software provides the following features.

- You can create a screen only with arranging components on it. Since each component provides functions of data display and switch input, few detail settings in a screen are necessary.
- Components in general use are provided as standard components and attached to the OIP. Using the standard components allows you to reduce time for creating screens remarkably.
- Since being able to customize a component, you can create your special screen easily. In addition, you can record the customized component in a library.
- Multiple components can be grouped and recorded for later use.
- Since an exclusive programming language (K-Basic) is offered, you can write a program easily not only for reading or writing PLC data, but for accumulating data and complex decision making.
- Settings for communication, such as PLC connection can be performed easily with parameter specifications. Further, you can perform list editing of PLC devices as well as device batch conversion between Mitsubishi and Omron.

1-2 Project

Explanation

Data created by Screen Creator 5 has four layers as described below. A project is placed at the topmost layer and consists of some screens. An example of the project is as follows.

- × × × processing machine operation panel project.
- plant monitoring project.
- manufacturing-process-monitoring panel project, etc.

Screen Creator 5 manages screen data in a unit of project. In addition, the following settings are also managed in a unit of project: PLC connection, host computer connection, and library settings.



- A project is equivalent to a system in Screen Creator 3.

First layer

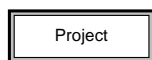

Consists of multiple screens.



Second layer

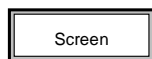

Consists of multiple components.

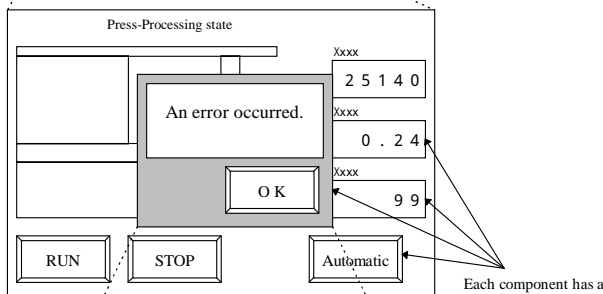

Third layer

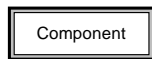

Consists of multiple controls.

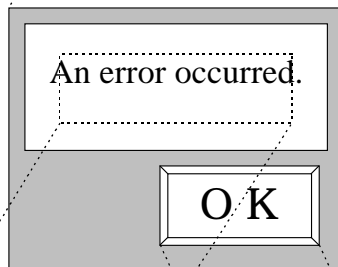

Fourth layer

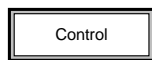

A minimum unit of functional elements comprising a project.



1-3 Screen

Explanation

This section explains a screen. One project consists of some screens. A screen is a fundamental unit of entering data and a switch. You may change a position where entering a pattern and switch for making a project of versatile functions. The OIP switches some screens in conformity with their functions. For instance, a plant-monitoring project consists of a menu, plant monitoring, plant monitoring, working condition monitoring, data entry, and maintenance screens.

The size of one screen is the same as that of the OIP screen.

(1) Local and global screens

Explanation

Screen Creator 5 handles two types of screens, global and local. A project has one global screen and some local screens. The OIP piles up the global screen and one of the local screens in the project.

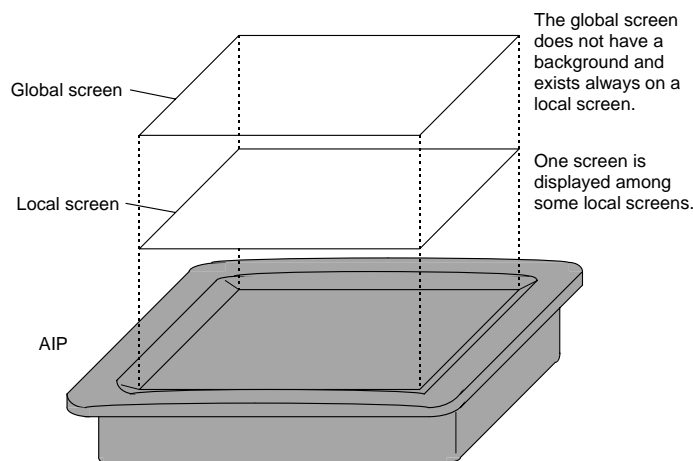

1. Local Screen

Create a local screen if you want to display a screen on the OIP screen. Switching a local screen causes an area for display and switch input to be changed at a time.

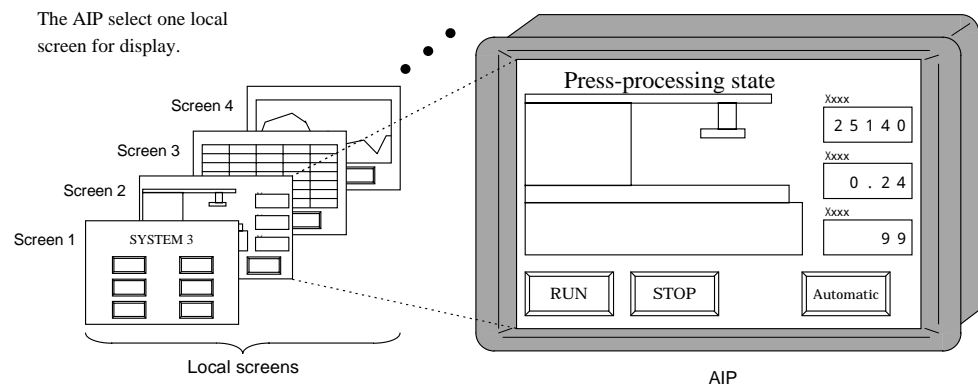

2. Global Screen

Explanation

A global screen exists always in the front of a local screen. You can see a local screen; for instance, the image is that your view is through a glass window (the global screen). The global screen always exists; thus it has functions, which inform you of an error, display a clock, and so forth, even though a local screen is present.

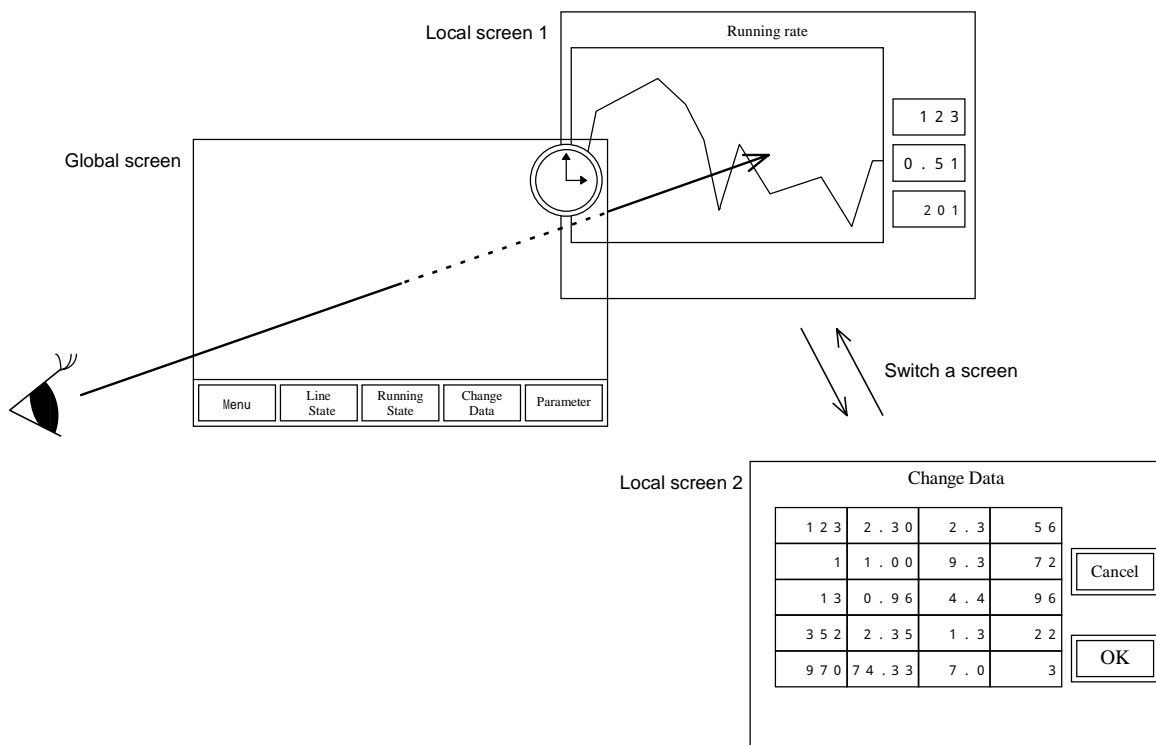

The actual screen is as follows.

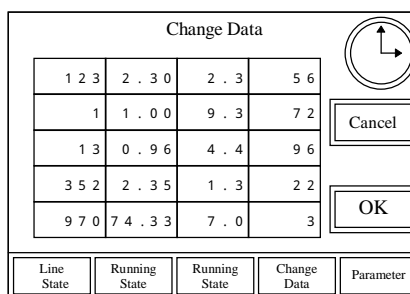
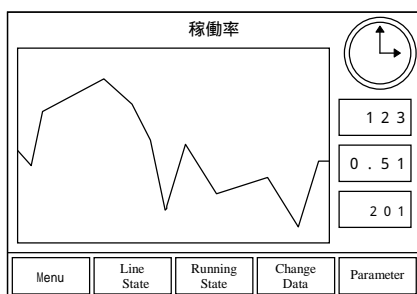

(2) Screen configuration

Explanation

This section describes screen configurations. A screen provides a data display function on the OIP screen, a setting function of switch input area, etc. These functions are realized with elements configuring the screen. In other words, Screen Creator 5 does not give these functions directly to the screen. Further, the screen consists of components, each of which plays a given role (such as informing an error and data entry). The screen consists of components and patterns.

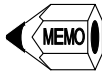

- Since various types of components are classified function-wise and recorded as libraries, you can save time for creating a screen.

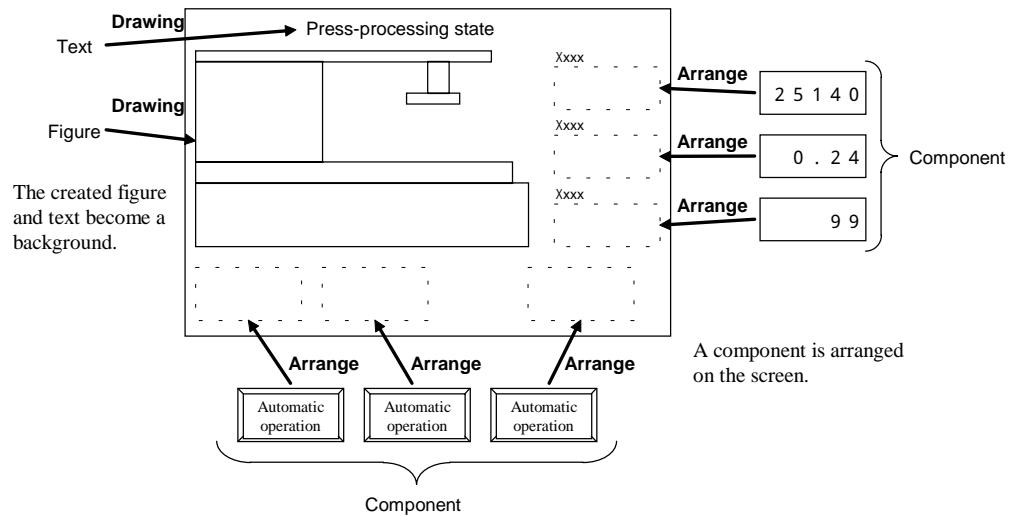

When a background is drawn and a component is arranged,
 a screen is completed.

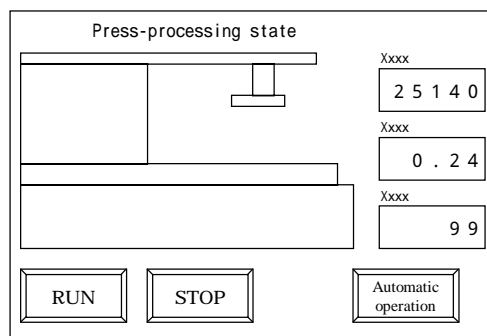

- A global screen does not have a background. Thus you cannot draw a figure on the global screen.
- A component arranged on a global screen is called a global component.

1-4 Component

Explanation

A screen consists of components and background. Components in a screen must play their given roles. For example, components comprising a maintenance screen are divided into the following roles: parameter setting, data entry (ten-key), screen switching, and date & time setting.

The component size is not limited, except it is not greater than that of the screen. The area of a component is, in general, enclosed with white-dot lines in Screen Creator 5.

(1) Component configuration

Explanation

As mentioned earlier, a component plays a given role in a screen. The component can be combined with a control (basic functional element), of which role (action) is decided by a program. Screen Creator 5 provides 16 types of controls, such as switch, numeric indicator, lamp, and meter. Further, a pattern is drawn as the background of the component like a screen. Thus, a component consists of a control, an operational program, and a pattern.

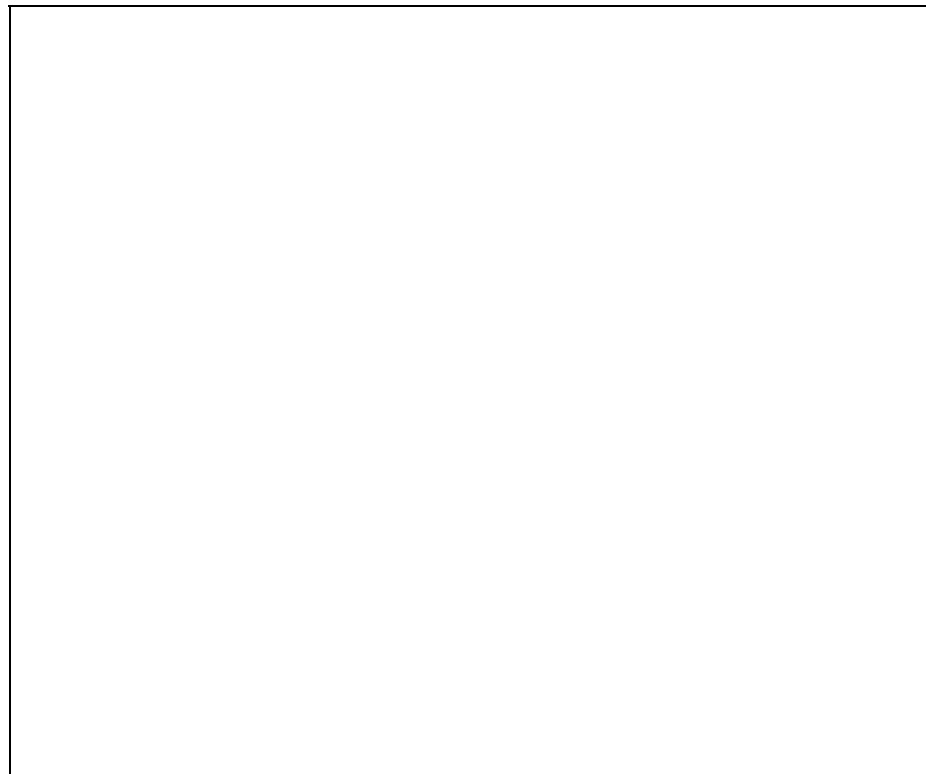

(2) Component attributes

1. Component status

Explanation

A component on a screen enters into any of the following four status.

- Normal (open)
A component is arranged on the screen as it is. In this state, you can display data and enter a switch as well.
- Close
No component is displayed on the screen. You can neither display data nor enter a switch.
- Write-protected
A component is displayed like the open state. In this state, you can display data but cannot enter a switch.
- Half tone
A component is displayed in half tone (in shade). You can neither display data nor enter a switch.

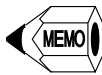

- The initial state of a component is set when the component is arranged.
- Before a component is made close, it must be made movable.
- The status and position of a component remain unchanged when their screen is switched. Accordingly, the screen displays the component with its original state when you go back to the screen. In other words, the component does not appear with the state and position when it was arranged.

2. Move a component

Explanation

You can move a component on a screen. A component of which movement is prohibited is called a non-movable component, and a component whose movement is allowed is a movable component.



- To make a component movable, it must be arranged with the movable attribute.
- A component arranged on a global screen is always movable.
- A total size of area for a movable component is greater than that of the screen, a part of the screen may not be displayed correctly.



3. Component overlapping

Explanation

When some components are overlapped in the OIP, controls of all components except the topmost one stop working. The overlapping means that components are piled up on their coordinates on the screen.



- When non-movable and movable components are overlapped, the movable one comes to the topmost position.
- When local and global screen components are overlapped, controls of the local screen components stop working.
- Since the global screen is placed on the local screen, a component arranged on the global screen is also put on that on the local screen.



- You cannot pile up non-movable components when creating a screen.

(3) Group components

Explanation

Some elements are grouped into one component. A group component consists of some components, an operation program, and a background.



- You cannot arrange a control to a group component.

1-5 Control

Explanation

A control is a basic functional element, comprising a project. A component manages a control with an operational program. For example, a switch control or character string indicator control is one of controls which configure components informing errors.

A control has an intrinsic area. On Screen Creator 5, switch and display controls are generally displayed with yellow and green dotted lines, respectively.



- A control is equivalent to a primitive in Screen Creator 3.

(1) Control types

Explanation

The control is roughly divided into two, switch control and display control. The switch and display controls are further divided into 2 and 14, respectively.

Switch control

- Switch
- Selector switch

Display control

- Numeric indicator
- Text indicator
- Clock indicator
- Figure indicator
- Plot graph
- Bar graph
- Line graph
- Belt graph
- Circle graph
- Free graph
- Slider
- Meter
- Lamp
- Pipe

(2) Control overlapping

Explanation

Controls can be arranged with overlapping. For example, if a numeric indicator and switch are laid to overlap each other for arrangement, you can create a component in which pressing a numeric portion causes a ten-key component to be open.



- Switch controls cannot be laid to overlap each other for arrangement.

(3) Action parameter for control

Explanation

Up to now, we explained that a program manages data display to a control or switch input from a control and also communicates with an external equipment. However, a control can also communicate with some external equipment without writing a program.

If making a control action parameter arranged in a component "effective", you can specify for communication a PLC device or memory table with the control.

1-6 Library

Explanation

Screen Creator 5 offers standard components and textures (a collection of figures) as a standard library. In addition, it allows you to use a character string and bit map libraries.

(1) Standard components

Explanation

A standard component library gathers frequently used components and arranges them as a library based on functions. The standard library is divided into two types, for color and monochrome. When you want to create a screen, select a component in the library and arrange it on the screen.

If not finding a suitable component, you can select a similar one in the library and modify (customize) it for creating the one you want. Then you may add it to a user component library, which you can use in another screen or project later.

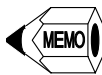

- Arranging a component on a screen means that a component in the library is copied on the screen. The component on the screen is independent from the one in the library. Thus, customizing the component on the screen does not affect the component in the library.
- Group components can also be added to a library.



- When a component in a library is modified, the modification is not applied to the copy of the component, which has been arranged on the screen.

(2) Recorded character string

Explanation

If a created character string is recorded in a library, it can be handled with its name or number. This character string is called a recorded character string, which can be displayed with its number of name.



- A library for recorded character strings is independent from another project. In addition, a library can be changed within a project. With this feature, you may share a character string library with another project. For example, one library is created in two languages (such as English and Japanese), and the library is switched to the other at downloading to the OIP. As a result, two types of libraries can be created with one project.

(3) Texture

Explanation

If some figures are grouped and recorded in a library, a recorded pattern can be handled with its name or number. This is called a texture, which can be displayed with its number or name. The recorded texture can be pasted as a background of a screen or component. In addition, you can directly specify a texture as a property of a specific control or component.

What you can specify as a texture is a figure, a character string, or a bit map.



- A texture arranged on a screen is not independent from the texture in the library unlike component arrangement. Thus, changing the texture in the library causes the texture arranged on the screen to be changed simultaneously.

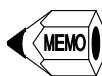

- A texture is equivalent to a registered figure in Screen Creator 3.

(4) Bit map

Explanation

Windows bit map files can be added to a library. Thus you can put a Windows standard bit map for the background of a screen or component.



- The number of colors for a standard bit map may be reduced in conformity with the OIP display colors.

1-7 System Timer

Explanation

The OIP uses the system timer for informing a component a timer.



- You must not set a timer interval short. If setting it short, you may not process components if they are many. When arranging components with the system timer, be conscious about the number of components and timer value.
- The number of timers you can use simultaneously is up to 16. It means that components works with timers are up to 16. Even though a component gets the right for using a system timer, it should release the right when not requiring the function anymore.

1-8 Colors

(1) Colors used in Screen Creator 5

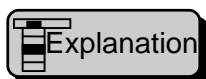

The colors used in Screen Creator 5 are based on the display model of the OIP.

1. Colors usable in a color OIP

Explanation

A color OIP is capable of displaying 15 colors out of 262144. Screen Creator 5 provides 16 palettes of which number is used to specify a color. Transparent is assigned palette number 0. You may select 15 colors out of 262144 and assign them to palette number 1 to 15.



- You can set color palettes per screen.
- The default colors assigned to palettes are as follows.

Number 0	Number 1	Number 2	Number 3	Number 4	Number 5	Number 6	Number 7
Transparent	Dark blue	Brown	Purple	Dark green	Cyan	Ocher	Gray
Number 8	Number 9	Number 10	Number 11	Number 12	Number 13	Number 14	Number 15
Black	Dark gray	Light gray	White	Blue	Red	Green	White

2. Colors usable in a monochrome OIP

Explanation

A monochrome OIP has three palettes: transparent, yellow (EI), and blue (LCD) are assigned number 0, 1, and 2, respectively. When creating a screen, specify palette numbers for the colors.

(2) Transparent

Explanation

Screen Creator 5 assigns number 0 palette transparent. If specifying the transparent, you can see the color under the assigned one.

(3) Basic color in an area

Explanation

The default colors of the backgrounds of elements are as follows.

Global screen	Local screen	Component	Control	Texture
Transparent	Black	Transparent	Transparent	Transparent

1-9 Downloading

Explanation

To display data created by Screen Creator 5 on the OIP, you must make the data usable with the OIP and transfer the resultant data to the OIP. Transferring data from a personal computer to the OIP is called downloading.

(1) Recording

To download data, it is necessary to record data subject to downloading.

1. Record a screen to be downloaded

Explanation

You cannot download a screen until it is recorded. When a screen is recorded, a number is attached. Hereafter, you can handle a screen with its number.

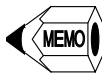

- When Screen Creator 5 is activated, the screen recorded first is displayed.

2. Record a texture and character string to be downloaded

Explanation

When a texture or character string in a library is specified with a number, it must be downloaded at the same time. Before downloading the texture or character string, it must have been recorded.

CHAPTER 2

INSTALLATION OF SCREEN CREATOR 5

2-1 Operation Environment

Explanation

Screen Creator 5 works in the following environment.

- Personal computer
CPU: Intel 80486SX or faster (Pentium or faster recommended)
Memory: 8 MB or more (16 MB or more recommended)
Operating system: Windows95
Hard disk: 30 MB or more free space
Floppy disk drive: 3.5" 1.44 MB
Display monitor: Resolution 640 × 480 (VGA) or higher (800 × 600 or higher recommended)
- Peripheral equipment
Mouse: A mouse fitting into Windows95
Printer: A printer fitting into Windows95
- OIP
Downloading cable: ??? (Koyo)
RS232C conversion connector: 25P-9P conversion (Necessary when ??? is used with a DOS/V machine.)

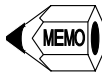

- There are two types of personal computers fitted to the above specifications, IBM PC compatibles (DOS/V machines) and PC98 series machines. You may employ either machine to run Screen Creator 5 when Windows95 controls it. You can also use either a desk top or note type.



- The upper limit of communication speed (RS232C) depends on how fast your computer is. The maximum transfer rate of Screen Creator 5 is 115.2 KB/sec. If your computer does not support such a high speed, lower the transfer rate.

2-2 Install Screen Creator 5

Explanation

Screen Creator 5 comes with floppy disks, which are called install disks. This section explains how to install Screen Creator 5 into a computer with the disks.

Procedure

Start up Windows95.

Copy install disks into other floppy disks, which are spare ones if original disks are destroyed and called backup disks.

Insert the first install disk into a floppy disk drive.

Click on the [Start] button and select [Run...] in the menu.

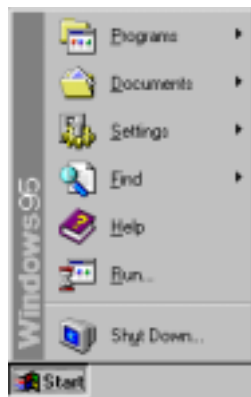

Enter [a:\setup.exe] in the Name: box. [a:] is the floppy disk drive name. Replace it with your drive name if the floppy disk drive is not [a:].

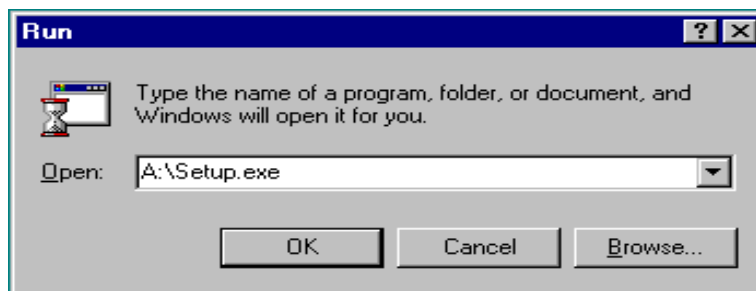

The installer starts. Then follow the instructions displayed on the screen.

When the installation has been complete, a short-cut icon to activate Screen Creator 5 appears.

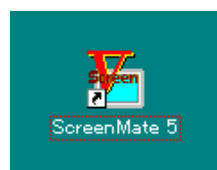

2-3 File Configuration after Installation

Explanation

When Screen Creator 5 has been installed, a folder is created with the specified name at the installation on the specified hard disk.

Drive name: ¥Sm5	Functions
— System	Holds executing and initializing files.
— Log	Holds system files.
— Lib	Accommodates project files (document files).
— Apt	Stores library data.
— Bmp	Stores color component files.
— Tex	Stores color bit map files.
— Aptm	Stores color texture files.
— Bmpm	Stores monochrome component files.
— Texm	Stores monochrome bit map files.
— Sample	Stores monochrome texture files.
	Stores sample project files.

"Sm5" is the folder name of initial setting at installation. If you have changed it, the specified name appears.



- Screen Creator 5 manages the folder configuration and files. Thus, if you make any change, such as a folder name change, file deletion, and content change, it may cause Screen Creator 5 to malfunction. Care must be paid.

2-4 Start Screen Creator 5

Explanation

When Screen Creator 5 has been installed, its short-cut icon is created on the desktop. In addition, the Screen Creator 5 icon is added in the [Program] menu on the [Start] button. You may use whichever you like for starting Screen Creator 5.

Procedure

- (1) To start Screen Creator 5 from the desktop.
Double-click the icon of Screen Creator 5 on the desktop.



- (2) To start Screen Creator 5 in the [Program] menu on the [Start] button.
Click on the [Start] button and select [Program] in the menu. Viewing the recorded applications, click on Screen Creator 5.

2-5 Uninstall Screen Creator 5

Explanation

This section explains how to uninstall Screen Creator 5. Once Screen Creator 5 is uninstalled, Screen Creator 5 and data accommodated in its folder are erased.



- Once Screen Creator 5 is uninstalled, not only Screen Creator 5 itself is deleted, but the project and library data stored in the folder are all removed.

Procedure

- (1) Delete the folder installing Screen Creator 5.
- (2) Drag the short-cut icon of Screen Creator 5 to the trash can.
- (3) Delete the short-cut of Screen Creator 5 from the start menu.

Click on the [Start] button and also click on the [Task bar] in [Setup].

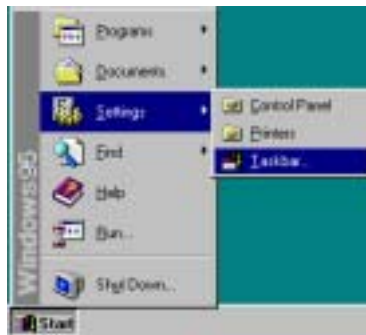

Click on the [[Start] menu settings] tab. Then click on the [Delete] button and select Screen Creator 5. Then, click on the [Delete] button again.



To know how to delete a folder, consult with Windows Help. On the Contents window in the Help function, click on [How to use Windows] and [Operate on files and folders].



- Screen Creator 5 does not change the Windows registry during installation.

CHAPTER 3

BASIC OPERATIONS FOR SCREEN CREATOR 5

3-1 Components and Functions of Screen Creator 5

(1) Names and functions

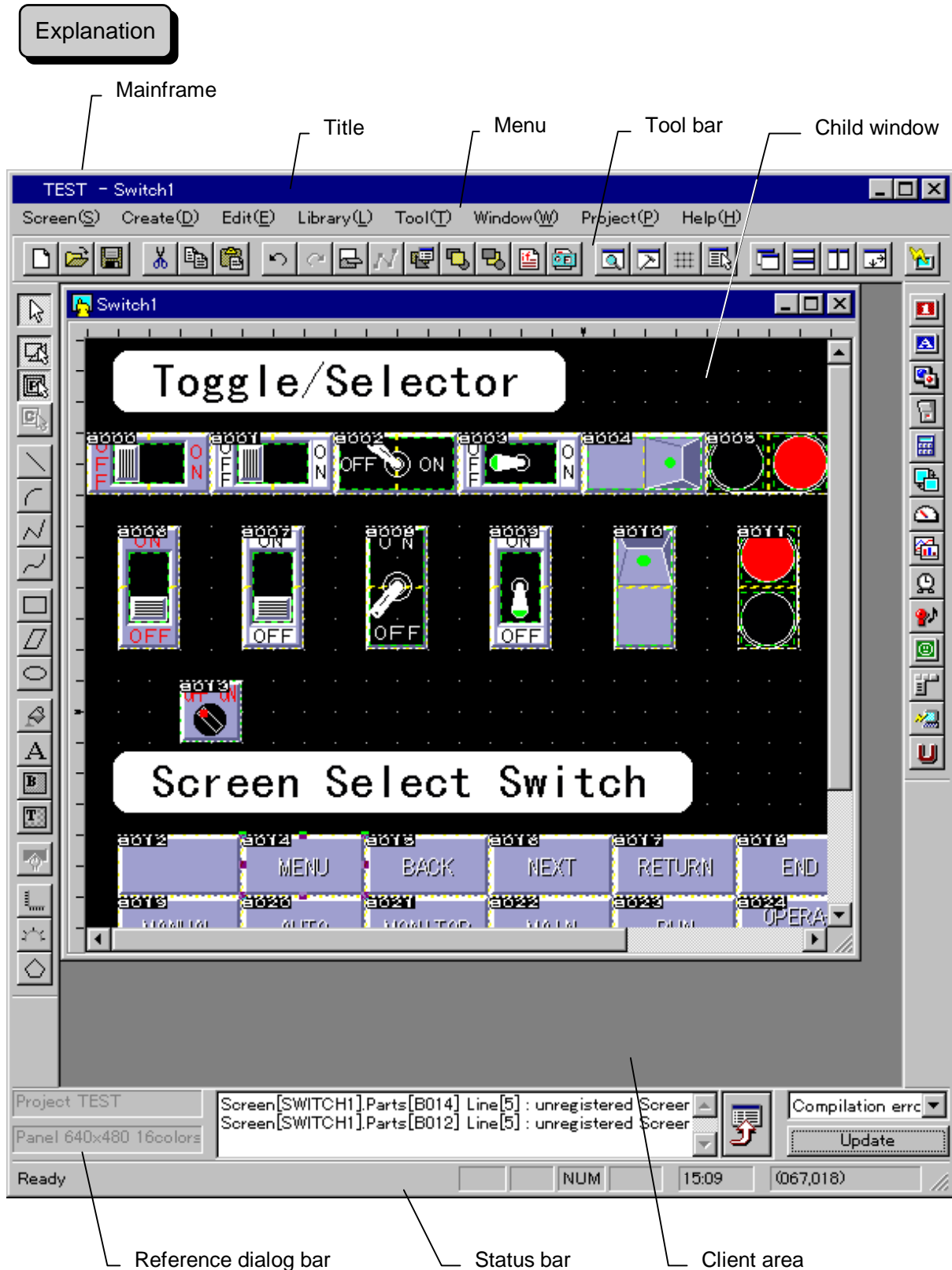

◇ Mainframe

The mainframe means a whole window. The center of the window, excluding menu bars, is called the client area, where you can create data and edit various elements, opening a child window.

◇ Title



The title bar is placed on the top of the mainframe and indicates texts and buttons. It is sometimes called a caption. In the bar, there include a project name and screen name, and the Minimize, Maximize and Close buttons.

◇ Menu

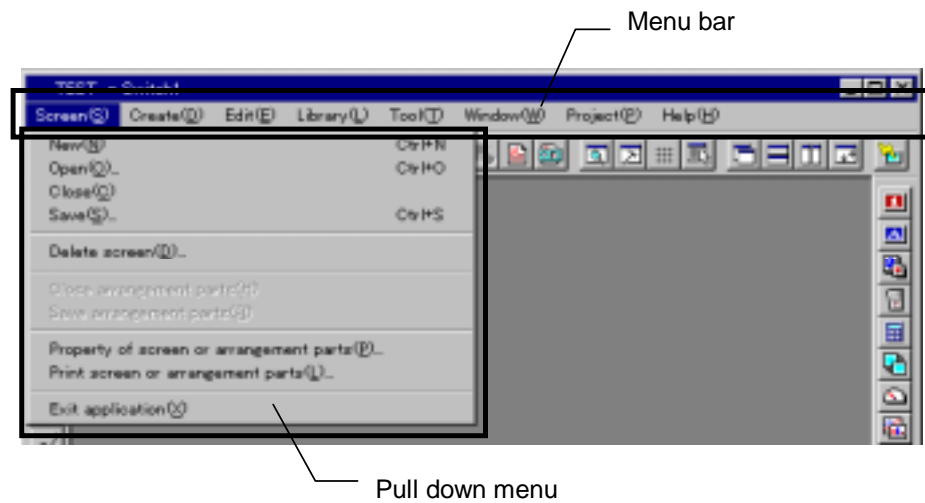

The bar under the title is the menu bar, in which basic operations are itemized and classified into function groups, and they are organized as pull down menus. For more information on functions of each item, refer to Chapter 4, Menu Reference.

◇ Tool bar



A tool bar is placed on each side of the mainframe, in which various buttons are arranged. Buttons on a tool bar, placed on the top or bottom, are arranged horizontally. When placed on the right or left side, the buttons are positioned vertically. Menu items and frequently used operations are assigned to the buttons. For more information on the tool bar, refer to Section 3-1 (2), Tool bar.



◇ Reference dialog bar

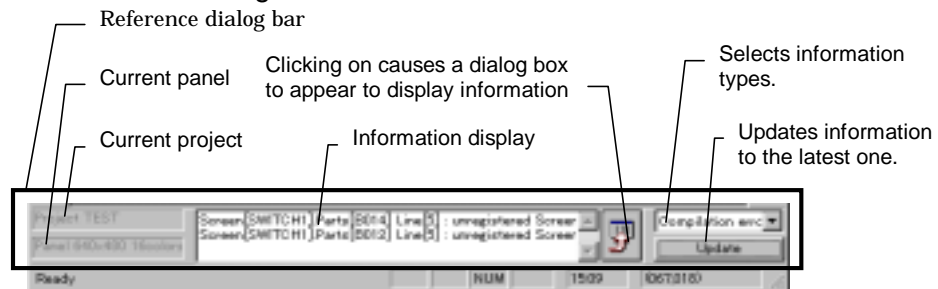

The reference dialog bar is a fairly large bar and placed on the bottom of the mainframe, which provides an information display area in the middle. On the left side of the bar indicates the current project and panel. On the right side of the bar, you can display various information, clicking on the [Update information to the latest] button. If you want to get more information, click on the right button of the display function.

◇ Status bar



The status bar is placed on the extreme bottom of the mainframe. This bar displays from the left a brief explanation of the current function, key lock state, time and the coordinate position of the current work.

◇ Child window

A child window is opened in the client area when the [Create] or [Open] function is executed. Use this window when creating or editing data. The window has the following features.

- A name appears on the title bar.
- More than one window can be opened.
- A child window can be maximized to a full screen in the client area.
- A child window can be minimized to an icon that is placed on the bottom corner of the client area.

◇ Dialog box

A dialog box is a window providing an input function, which is a basic operation of work. The operator cannot move to another window until the opened dialog box is closed (canceled).

◇ Modeless dialog box

This dialog box is a special dialog box to be opened in a specific operation. The attribute dialog box during drawing is an example of this dialog box. Unlike another dialog box, you can move from this dialog box to another window, or vice-versa. In other words, this dialog box can coexist with child windows.

(2) Tool bar

Explanation

A tool bar has buttons on which a procedure for selecting a menu or mode switching is assigned. On the mainframe, there are four tool bars, standard, drawing, control, and component. When installation has been complete, all tool bars except for the control are combined into one and appear in the mainframe.

The tool bars provide the following features.

- Docking and floating

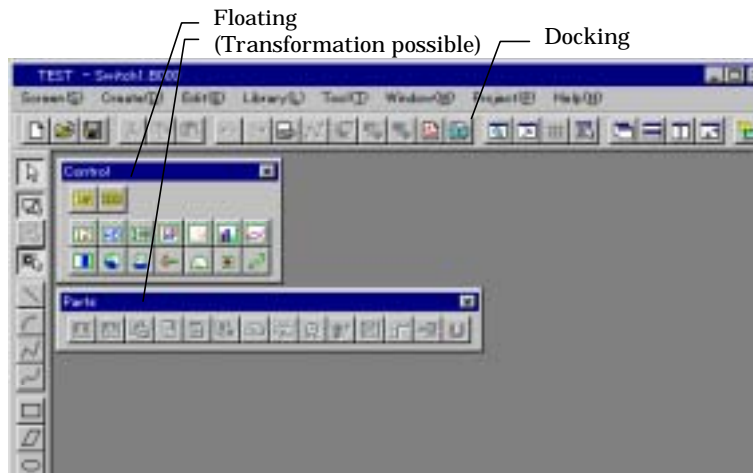

Every tool bar can exist in two modes, docking and floating. In the former mode, a tool bar sticks to a side of the mainframe; in the latter, it exists at any location in the mainframe (floating). You can drag the floating bar (grabbing its upper portion) to anywhere within the main frame and switch it to another as well as you can dock with the side of the mainframe. In the floating state, you can change the size horizontally and vertically. In addition, the floating tool bar is never behind a child window.

- Display and non-display

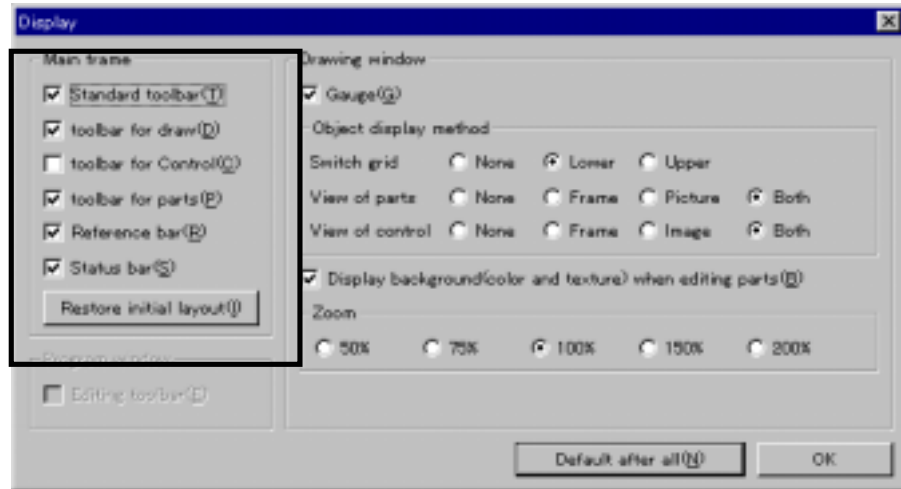

You can change a tool bar from display to non-display state or vice-versa, from a dialog on its opened window.



- When the tool is activated, the tool bar status is the same as that at the last close of the tool. If the sizes of the tool bar are different between the startup and the last close, the tool bar may disappear on the desktop. Should it occur, Select [Display] on the tool menu to open a dialog and execute the [Return to the initial state] function.

- Tips

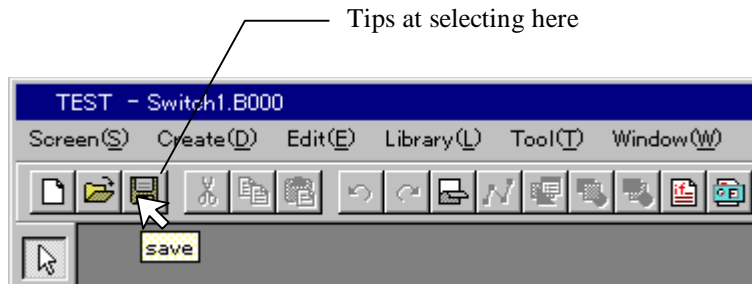

A tool bar button has a brief explanation (tips) of its function. When you position a cursor on a button, a brief explanation (tips) appears 0.5 second later. When the cursor goes away from it, the explanation disappears.

- Operation object

























In an environment of some child windows, the function of a selected tool bar is applied to the child window in focus (the window with its title bar highlighted). In other words, you must focus on the objective child window before applying a function on it. For focusing, click on the title of a child window.

1. Standard tool bar

Explanation



This tool bar provides common functions frequently used in the menu items. This section represents the correspondence of icons to the menu functions. For details, refer to Chapter 4, Menu Reference.



















	[Screen (S)] - [New (N)]
	[Screen (S)] - [Open (O)]
	[Screen (S)] - [Save (S)]
	[Edit (E)] - [Cut (T)]
	[Edit (E)] - [Copy (C)]
	[Edit (E)] - [Paste (P)]
	[Edit (E)] - [Undo (U)]
	[Edit (E)] - [Redo (W)]
	[Edit (E)] - [Refresh (R)]
	[Edit (E)] - [Corner (Z)]
	[Edit (E)] - [Change attributes or properties (E)]
	[Edit (E)] - [Change order (T)] - [Move to front (F)]
	[Edit (E)] - [Change order (T)] - [Move to back (B)]
	[Edit (E)] - [Edit screen program/Edit parts program (B)]
	[Edit (E)] - [Edit an action parameter (V)]
	[Tool (T)] - [Display (V)]
	[Tool (T)] - [Option (O)]
	[Tool (T)] - [Option (O)] - [Snapshot/Enable (X)]
	[Tool (T)] - [List browse (B)]
	[Window (W)] - [Cascade (C)]
	[Window (W)] - [Vertical tile (H)]
	[Window (W)] - [Horizontal tile (T)]
	[Window (W)] - [Arrange to object size (O)]
	[Project (P)] - [Download (D)]

2. Drawing tool bar

Explanation



This tool bar provides creating (drawing) functions for drawing elements. This section represents the correspondence of icons to the menu functions. For details, refer to Chapter 4, Menu Reference.

-  [Create (D)] - [Select mode (D)]
-  Select drawing (makes a drawing element effective as a selection object)
-  Select parts (makes a component effective as a selection object)
-  Select control (makes a control effective as a selection object)
-  [Create (D)] - [Straight line (L)]
-  [Create (D)] - [Arc (A)]
-  [Create (D)] - [Continuous straight line (V)]
-  [Create (D)] - [Spline (W)]
-  [Create (D)] - [Rectangle (R)]
-  [Create (D)] - [Parallelogram (Q)]
-  [Create (D)] - [Circle/Ellipse (E)]
-  [Create (D)] - [Fill (F)]
-  [Create (D)] - [Character (S)]
-  [Create (D)] - [Bitmap (B)]
-  [Create (D)] - [Texture (T)]
-  Display/no-display of attribute dialog
-  [Create (D)] - [Macro (M)] - [Line-shaped scale (L)]
-  [Create (D)] - [Macro (M)] - [Circular scale (C)]
-  [Create (D)] - [Macro (M)] - [Polygon (D)]



- Settings of effectiveness/ineffectiveness for drawing, component, and control selections can be performed independently in individual child window. If you are working with some child windows, be careful for each window to be effective.

3. Control tool bar

















Explanation



This tool bar provides creating controls. The buttons on this tool bar are effective only when you are creating or editing a component.



This section represents the correspondence of icons to the menu functions. For details, refer to Chapter 4, Menu Reference.

	[Create (D)] - [Control (C)] - [Switch (S)]
	[Create (D)] - [Control (C)] - [Selector switch (S)]
	[Create (D)] - [Control (C)] - [Number indicator (N)]
	[Create (D)] - [Control (C)] - [Character indicator (T)]
	[Create (D)] - [Control (C)] - [Clock indicator (C)]
	[Create (D)] - [Control (C)] - [Figure indicator (F)]
	[Create (D)] - [Control (C)] - [Plot (D)]
	[Create (D)] - [Control (C)] - [Bar (B)]
	[Create (D)] - [Control (C)] - [Break line (G)]
	[Create (D)] - [Control (C)] - [Band (Z)]
	[Create (D)] - [Control (C)] - [Circle (E)]
	[Create (D)] - [Control (C)] - [Free (X)]
	[Create (D)] - [Control (C)] - [Slider (Y)]
	[Create (D)] - [Control (C)] - [Meter (M)]
	[Create (D)] - [Control (C)] - [Lamp (L)]
	[Create (D)] - [Control (C)] - [Pipe (P)]

4. Component tool bar

Explanation



This tool bar provides creating (arranging) functions for components. The buttons on this tool bar are effective only when you are creating or editing a screen.



This section represents the correspondence of icons to the menu functions. For details, refer to Chapter 4, Menu Reference.

	[Create (D)] - [Parts (P)] - [Number indicator (N)]
	[Create (D)] - [Parts (P)] - [Character indicator (T)]
	[Create (D)] - [Parts (P)] - [Lamp (L)]
	[Create (D)] - [Parts (P)] - [Switch (S)]
	[Create (D)] - [Parts (P)] - [Ten-key/Keyboard (I)]
	[Create (D)] - [Parts (P)] - [Change screen (C)]
	[Create (D)] - [Parts (P)] - [Meter (M)]
	[Create (D)] - [Parts (P)] - [Graph (G)]
	[Create (D)] - [Parts (P)] - [Clock/Calendar (P)]
	[Create (D)] - [Parts (P)] - [Alarm (A)]
	[Create (D)] - [Parts (P)] - [Figure indicator (F)]
	[Create (D)] - [Parts (P)] - [Special parts (X)]
	[Create (D)] - [Parts (P)] - [host command communicate (H)]
	[Create (D)] - [Parts (P)] - [User parts (U)]

3-2 Basic Operations for Mouse and Keyboard

Explanation

The procedure for creating a screen and component is in conformity with that of general drawing tools of Windows. The procedure is as follows.

- Open a window.
- Select a type of creation with a menu or tool bar.
- Creation with a mouse.
- Returns to the selection mode.
- Select an editing object.
- Do editing.
- Close a window.
- Operations performed with a mouse are as follows.

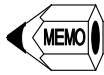

- Click: Press the left button and release it quickly.
- Right-click: Press the right button and release it quickly.
- Drag: Move the mouse with the left button pressed and release it.
- Double-click: Click left button twice quickly.

(1) Create an element of a screen or component (drawing)

Procedure

Select an object in the menu or click on a drawing tool bar button. Then the tool bar button is made the ON state. The cursor becomes a cross. The attribute dialog is open. Finally, you are in the creation mode. (In macro creation, a dialog is open before mode switching for entering a parameter.) In the attribute dialog, enter parameters for a color, paint, etc.

Specify a coordinate with dragging or clicking. Referencing a shape, move the mouse to make a figure you want. After creation (when you are drawing a straight line or spline, only you must to do is double-clicking), a figure is drawn with the specified parameter.

When having finished one operation, you may create the same element in succession. To end the creation, select the [Create] - [Select mode] functions in the menu, click on the select mode button on the drawing tool bar, right-click, or press the ESC key. To create another type of element, select an object in the menu or click on another button on the drawing tool bar.



- During creation of a drawing element, the Shift or Ctrl key functions as follows.

Line

Shift key: Horizontal-vertical conversion

Arc

Shift key with the 1st - 2nd dots: Square conversion

Ctrl key with the 1st - 2nd dots: Center dot conversion

(The 1st dot is the center of a circle.)

Shift key with 3rd - 4th dots: Horizontal-vertical conversion

Continuous line

Shift key: Horizontal conversion

Spline

Shift key: Horizontal conversion

Rectangle

Shift key: Square conversion

Parallelogram

Shift key: Horizontal conversion

Circle/Ellipse

Shift key: Square conversion

Ctrl key: Center dot conversion (The 1st dot is the center of a circle.)



- While you are creating an element, the following keys are effective.

Cursor key

The mouse cursor moves in the direction of a pressed key.

Enter key

Pressing this key (coordinate direction) causes the same effect of clicking the left mouse button.

ESC key

Pressing this key causes the same effect of clicking the right mouse button.

Q key

Pressing this key causes the mouse cursor to move the nearest distinctive portion (such as an edge of a figure).



- When snap is made ON, the coordinate is restricted to a grid. This is convenient for positioning. To make snap ON, click on the Snap ON/OFF button on the drawing tool bar. In addition, opening the dialog with the option of the tool menu allows you to specify a grid size.

(2) Create a component on a screen (arrangement)

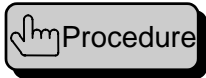

Click on the menu or tool bar button to change to the selection mode.

Select an objective component type in the menu or click on the component tool bar button. Then a dialog for selecting a component appears.

When an objective component is selected, the dialog is closed. Then a dialog box for the arranging component is open. Then enter a parameter and click on the [OK] button.

When the shape of the cursor changes to a mouse, perform left-click on the screen. Then a reference frame showing a component shape appears. Bring the shape with the mouse to a position you want and click on the position. The component is then pasted on the screen. This is the end of the creation. Then the mode is returned to the selection mode.



A fixed component (non-movable component) cannot be created at the overlapping position of another fixed component.

(3) Create a control to a component



The procedure for creating a control to a component is as follows.

Click on the menu or tool bar button to change to the selection mode.

Select an objective component type in the menu or click on the component tool bar button.

When a control parameter is entered, the dialog is opened. Then enter a parameter and click on the [OK] button.

When the shape of the cursor changes to a mouse, perform left-click on the screen. Then a reference frame showing a component shape appears. Bring the shape with the mouse to a position you want and click on the position. The control is then pasted on the screen. This is the end of the creation. Then the mode is returned to the selection mode.



A switch control and selector switch control cannot be created at the overlapping position of another switch.

(4) Edit a created entity (drawing element, component, and control) with a command.

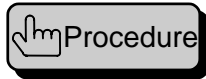

This section explains how to edit a created entity with a command.

The procedure for editing with a function in a menu is as follows.

Select an object you want to edit, clicking a frame or inside of the object. Once an object is selected, handles (small squares) appear on the four corners and the center of the four sides.

Select an editing function in the edit menu. Some common functions are assigned to buttons on the standard tool bar.

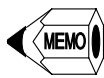

- The clicking positions for selection are as follows.
 - Drawing element: Any seeing position of a shape. If the element is painted, any colored position is available.
 - Component: Inside of the area. In the close state, only the frame is available.
 - Control: Frame only.
- There are three ways to select multiple entities.
 - (1) Pressing and holding the Shift key, click on an object in succession. If you click on an already selected object, the selection is released.
 - (2) Enclose objects with a dragging frame. All objects in the frame are selected. In other words, entities outside of the frame are deselected. If an object exists at the start position of the dragging, you cannot begin the operation. Then press the Shift and Ctrl keys at the same time to allow the dragging.
 - (3) Select the [Browse a list] function on the tool menu. Then a dialog is opened and a list of selectable objects is displayed. Then pressing and holding the Ctrl key, click on an item in succession to display multiple items in the reverse image. When the [Execute the selection] button is pressed, the dialog is closed and the selection is reflected on the screen.
- To release the selection click on the screen where no element exists. Or change to any creation mode.
- When right clicking is performed with a selected item, an editing menu (context menu) is popped up. Then select it for editing.

(5) Edit a created entity (drawing element, component, and control) with a handle.

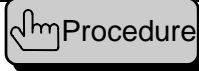

This section explains how to edit a created entity with a handle.

The procedure for moving or transforming with a handle is as follows.

The selecting methods are the same as those in the command.

When a cursor is brought to a selected entity, its shape changes depending on the editing type. Then you can edit with the cursor. The correspondence of the cursor and editing types is as follows.

Cross sign: The cursor moves when you drag.

Up/down/right/left arrow: The cursor moves in its direction when you drag.

Slant arrow: The cursor moves in the two directions when you drag.

When double-click is made, you can edit attributes/properties. When a cursor is brought to a name at the left upper of component display, the cursor becomes P. Then you can edit contents of the component with double-click.

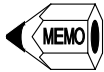

- When a cursor is pressed with an entity selected, the selected one moves toward the cursor.
- When a continuous line is selected, choosing a vertex editing from the menu or tool bar, the handle position changes from a corner to a vertex. Then you can move a handle to shift a coordinate of the vertex.
- When you move an entity with the Shift key pressed, the movement is restricted horizontally or vertically.
- When you move an entity with the Ctrl key pressed, the source of the entity remains unchanged. That is, the operation is equivalent to the copy.
- When you perform a transforming operation with the Shift key pressed, the transformation makes a similar figure.



A component having an internal switch or a switch control is limited in transforming operation. Possible figures for transformation are displayed in reference.



A component not movable (fixed component) cannot be piled up as well as a switch control.

(6) Component area

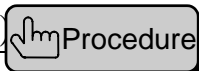

This function changes a component area.

While a component is being edited, the editing area is enclosed with a dot frame. At the center of the four-sided frame, there is a red portion. When a cursor is brought to the red portion, the cursor changes to an arrow with a bar. Then drag to change the area.

3-3 Basic Operation for Downloading

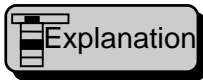

Explanation

Screen data created with Screen Creator 5 is sent to the OIP via serial communication. The operation is referred to as screen data downloading.

The downloading operations are as follows.

Connect your computer to the OIP with a downloading cable.

Generate downloading data from project screen data.

Transfer downloading data to the OIP.

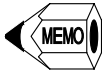

- Generating downloading data includes screen and component figure information is processed into the OIP data as well as a K-Basic program into the OIP data. The K-Basic program processing is called compilation like other programming languages.

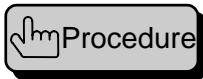

Procedure

Select [Project] - [Download] from the menu or click on the [Download] button on the standard tool bar. Then the following downloading dialog is opened.

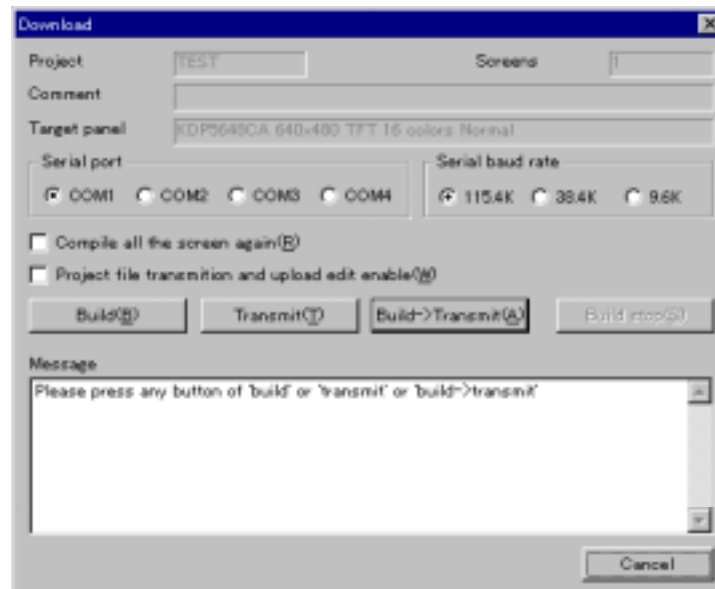

Click on the [Create] button. If an error occurs during data generation, an error message appears in the message area. If the error occurs during compilation, correct the program referencing the error information. Then generate downloading data again.

When generating downloading data is successful, download it. For the downloading, your computer must have been connected to the OIP, which must be in the downloading mode. Then set a serial port channel and transfer rate. This setting must have been done before the downloading but once is enough. In other words, when the downloading is attempted next time, the downloading dialog is opened with the same settings. Finally, click on the [Send] button.

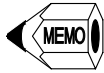

- The exclusive cable for the downloading is ????. When you want to use a DOS/V machine, obtain a connector converting DSUB25P to DSUB9P in a common market; the connector is a general-purpose component PC98's RS232C to DOS/V machine's RS232C.

To make the cable, refer to the following diagram (the cable length must be shorter than 3 m).

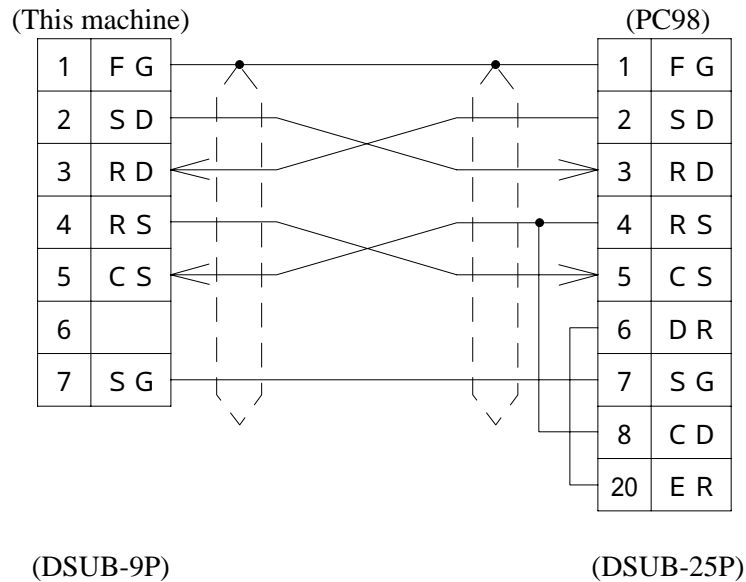

- Recommended connectors
 Plug: HDEB-9P (Hirose) or equivalent
 HIDBB-25P (Hirose) or equivalent
 Shell: HDE-CTF (Hirose) or equivalent
 HDB-CTF (Hirose) or equivalent

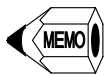

- To make the OIP in the downloading state, press the touch switches on the left upper and right down corners at the same time. Then click on the [Download] in the system menu.



- The upper limit of communication speed (RS232C) depends on how fast your computer is. The maximum transfer rate of Screen Creator 5 is 115.2 KB/sec. If your computer does not support the speed, lower the transfer rate.

CHAPTER 4

MENU REFERENCE

4-1 Screen (S)

(1) Create (N)

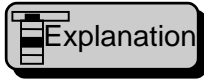

Explanation

This function opens a screen to be created.

(2) Open (O)

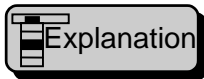

Explanation

This function opens a screen to be edited among the stored screens.

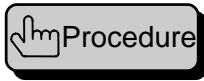

Procedure

The [Open screen] dialog box appears.
Select a screen to be edited.

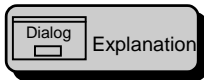

Dialog Explanation

[Open screen]

An entry number to be downloaded to the AIP.
Select a folder where the screen file exists.

Screen file size.

Date saved last.

Comment on the screen.

File names appear together with the screen names. Clicking here allows the file names to be displayed in the ascending order.

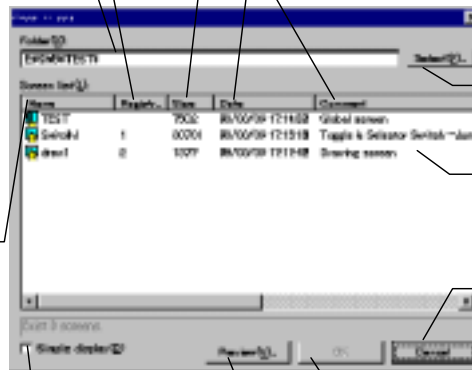

Select the place accommodating the screen.

Select a screen to be opened.

Cancel the screen opening operation.

The list changes only screen names.

Opens the selected screen.
Displays the [Preview screen] dialog box, where you can select a screen with a drawing pattern.

◇ Place of the screen (X)

The project folder is the default value. Usually, you need not change the directory for the screen. If you want to use a screen for another project, select it here.

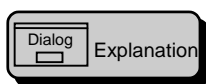

[Preview screen]



Select a screen on the list.

Terminates this dialog and returns to the screen name display.

You may reference an entire screen.

Opens the selected screen.

(3) Close (C)

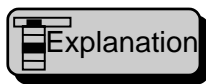

This function closes the active screen you are editing at present. If the screen contents have been changed, a dialog box confirming the screen saving appears.



- If you select [NO] in the dialog box, all changes applied to the screen are made invalid.



To save the screen, [Save screen] dialog box appears. For more information on the dialog box, refer to Section 4-1 (4), Save.

(4) Save (S)



This function saves the active screen you are editing at present.



The [Save screen] dialog box appears.
Enter a name of the screen and a comment before saving.



[Save screen]

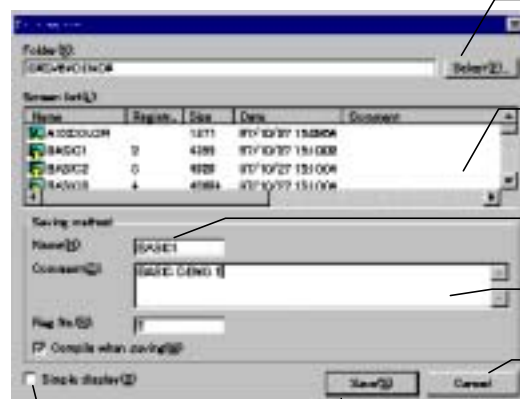

Select the place where the screen is to be saved.

Saved files appear on the screen place.

Enter a screen name.

Enter descriptions on the screen.

Cancel the screen saving operation.

The list changes only screen names.

Saves the screen.

- ◇ Place of the screen (X)
Enter a folder name where the screen file is saved. The project folder is the default value. Usually, you need not change the directory for the screen. If changing the folder name, you cannot use the screen being edited in the current project.
- ◇ Entry number (R)
When saving the screen, enter a screen to be downloaded. Specify the number for the screen that will be downloaded.



For more information on the screen entry, refer to section 4-8 (6), Entry.

- ◇ Compile at saving the screen (W).
Marking this check box allows a temporary file for downloading data to be also created when the screen is saved.



- Compiling the screen file may cause a compile error if the file creation has not been complete.

(5) Delete a screen (D)

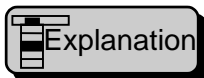

This function deletes a saved file.

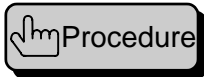

The [Select screen] dialog box appears.
Select a screen to be deleted.

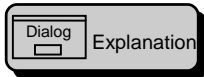

[Select screen]

An entry number for downloading to the AIP.

Screen file size.

Date saved last.

Comment on the screen.

Select the place accommodatin

Select a screen to be opened.

Cancel the screen deleting operation.

Deletes the selected screen.

Displays the [Preview screen] dialog box, where you can select a screen with a drawing pattern.

The list changes only screen names.

Select the folder where the screen file exists.

File names appear together with the screen names. Clicking here allows the file names to be displayed in the ascending order.

Screen Name	Region	Size	Date	Comment
AXM0000R		1877	07/18/21 09:09:54	
BAG001	2	4009	08/08/08 10:14:00	BAG001 DEMO 1
BAG002	3	4009	08/08/08 10:43:00	BAG002 DEMO 2
BAG003	4	4009	08/08/08 10:43:44	BAG003 DEMO 3
BAG004	3	19062	08/08/08 10:44:00	BAG004 DEMO 4
BMFFILE	8	01020	08/08/08 10:44:00	BTMAP
DEMOLM11	7	41424	08/08/08 10:15:14	Lamp 11
DEMOLOG00	8	40077	08/08/08 10:06:00	Toggle/Selector Switch 07
DEMOLOG01	8	50020	08/08/08 10:05:00	Mark Switch
DEMOLOG02	10	02260	08/08/08 10:43:24	Manual Display and Change
DEMOLOG03	11	109967	08/08/08 10:11:01	Manual Stop/Start and Change



For more information on dialog box for the [Preview screen], refer to section 4-1(2), Open.

◇ Place of the screen (X)

The project folder is the default value. Usually, you need not change the directory for the screen. If you want to use a screen for another project, select it here.

(6) Close arrangement parts (H)



This function terminates editing components arranged on the screen and closes the window. If the screen contents have been changed, a dialog box confirming the screen saving appears.



- If you select [NO] in the dialog box, all changes applied to the screen are made invalid.

(7) Save arrangement parts (R)

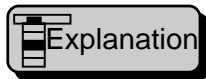

This function saves edited results of the components arranged on the screen. If controls and figures exist out of the components, a dialog box confirming the saving operation appears.

(8) Property of screen arrangement parts (P)

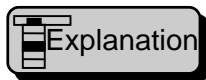

This function changes screen or component properties respectively when the screen window or component window is active.

1. Screen property change



The [Property of Screen] dialog box appears.
Set the screen color palette.



- The color palette settings are effective only for the color type screen.

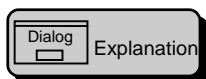

[Properties of Screen]

Select a palette to be changed.

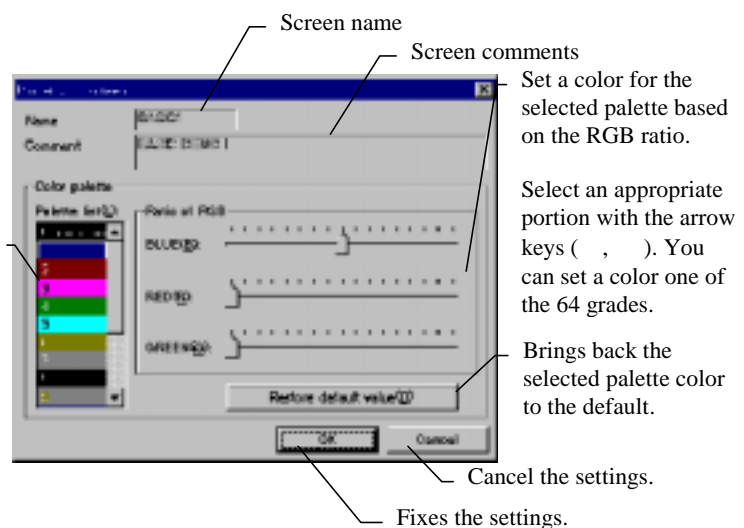



For more information on the default color of the color palette, refer to Section 1-8 (1) Colors used with Screen Creator 5.

2. Component property change

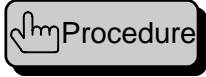

The [Property of arranging parts] dialog box appears. Set the component area and background.

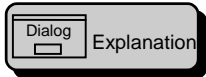

[Property of arranging parts]

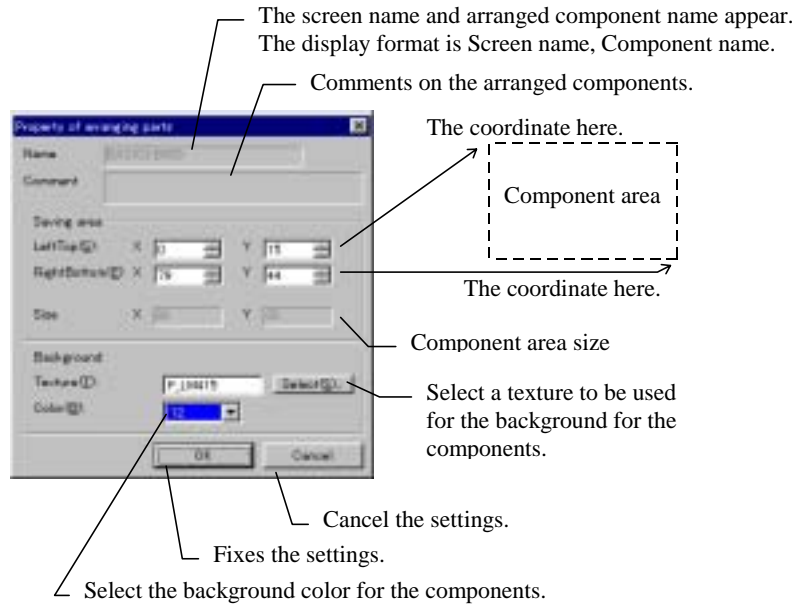

- ◇ Area to be saved
Enter the left upper coordinate (S) and right lower coordinate (E).
- ◇ Texture (T).
Enter the name of a texture to be used for the background of the components. You may select it in the library when clicking on the Select (S) button.
- ◇ Color (B)
Select the background color.

(9) Print screen or arrangement parts (L)

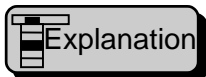

When the screen window is active, the background of the screen is stored in a bit map file, and screen and arranged component information is in a text file. When the component window is active, the background of the components is stored in a bit map file, and component and control information is in a text file.



The [Print screen] or [Print arrangement parts] dialog box appears. Select an item to be saved and enter the name of a file accommodating the information. Execute the saving.

Dialog Explanation
[Print screen]

A list of arranged components is written in the specified output file.

The background information is written in the specified output file.

Enter a bit map file accommodating the background.

Writes onto the specified output file action parameters of the screen.

Enter the name of a text file accommodating screen and arranged component information.

Writes onto the specified output file the screen program.

Cancel the documentation.

Executes the saving.

Writes settings of the controls that the selected components use onto the output file.

Writes the program for the selected components onto the output file.

Writes action parameters for the selected component onto the output file.

Select arranged component information to be saved.

Properties of the selected component are saved.

Saves a list of controls of the selected component.

Dialog Explanation
[Print arrangement parts]

The background information is written in the specified output file.

Enter a bit map file accommodating the background.

Enter the name of a text file accommodating arranged component information.

Cancel the documentation.

Executes the saving.

Writes control settings onto the output file.

Writes the component program onto the output file.

Writes action parameters for components onto the output file.

Saves a list of component controls.

(10) Exit application (X)

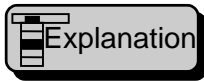

This function terminates Screen Creator 5. If an unsaved screen, component, a texture, and/or a bit map exist, a dialog box confirming the saving operation appears.



- If you select [NO] in the dialog box, all changes applied to the components are made invalid.

4-2 Create (D)

(1) Select mode (D)

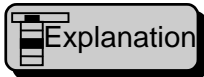

Explanation

This function terminates the drawing mode and goes into the mode controlling patterns and components. When a checking mark exists in the menu, you can use this mode.

(2) Straight line (L)

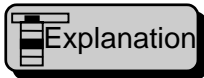

Explanation

This function draws a line, dots, and an arrow.



Procedure

The [Straight line] dialog box appears.
Set line attributes.
Specify a start point and end point.

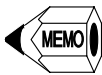

- Specify two dots at the same position to draw a dot.
- Press and hold the [Shift] key to draw a horizontal or vertical line.

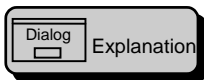

Dialog Explanation

[Straight line]

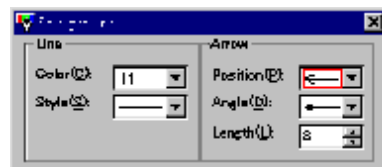

- ◇ Color (C)
Select a color for the line in the pallet.
- ◇ Style (S)
Select a type and thickness of the line.
- ◇ Position (P)
Select a position for the arrow.
- ◇ Angle (D)
Select an angle for the arrowhead.
- ◇ Length (L)
Specify the length of the arrowhead in dots. The length of an arrowhead is from 1 to 32 dots.

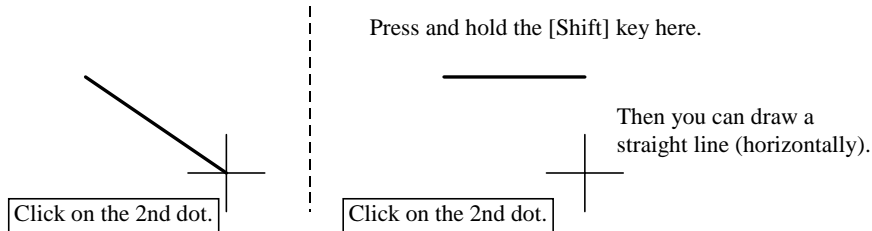
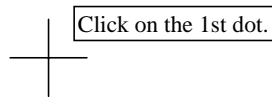
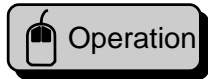

(3) Arc (A)

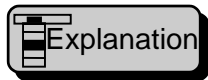

This function draws an arc and fan.
The [Arc] dialog box appears.

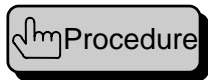

Set attributes for the arc.
Draw a base circle, using the first two dots. (The circle is inscribed with the rectangle with the diagonal of the two dots.)
Specify the start and end points with the third and fourth dots.



- Press and hold [Shift] to draw a circle.
- Press and hold [Ctrl] and specify the first two dots. Then you can draw a circle with first dot as the center of the circle.
- Press and hold [Shift] and specify the start and end points of an arc. Then you can draw an arc with the start and end angles of 0°, 90°, 180°, and 270°.

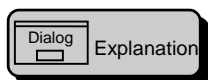

[Arc]



- ◇ Color (C)
Select a color from the palette for the circumference of the circle or fan.
- ◇ Style (S)
Select a thickness of the line of the circumference of the circle or fan.
- ◇ Line(A)
Marking this check box draws a fan.
- ◇ Tile (T)
Select a tile pattern filling a fan.
- ◇ Forehand (F)
Select a color in the palette for the black portion of the tile pattern.
- ◇ Back(B)
Select a color in the palette for the white portion of the tile pattern.



- No filling a fan is performed in the following conditions: (1) the fore-color and back-color are transparent, (2) the back-color is transparent in the first tile pattern, and (3) the fore-color is transparent in the second tile pattern.
- When filling is specified, a fan is always drawn.

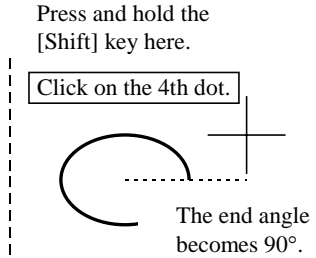
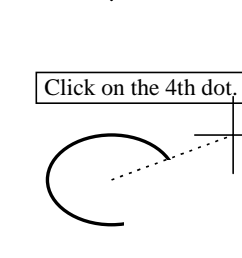
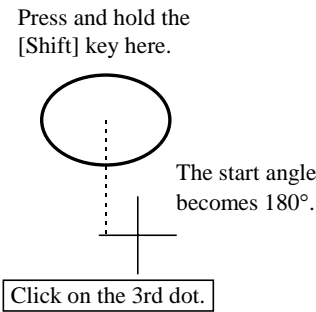
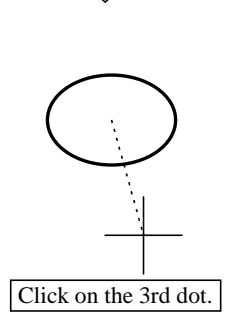
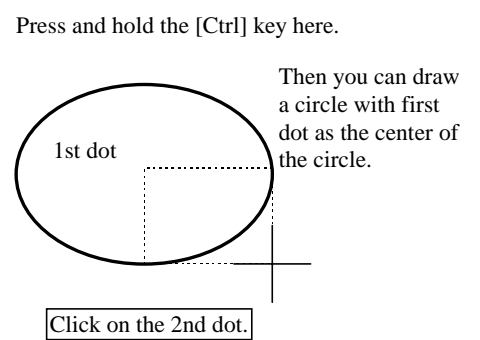
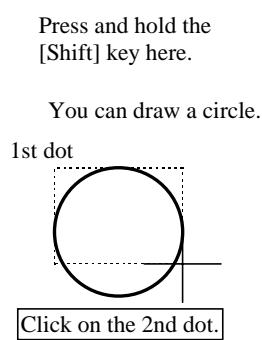
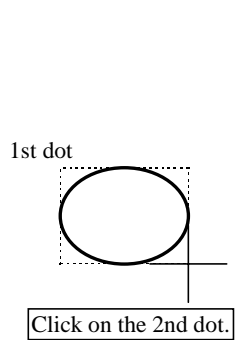
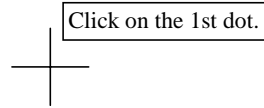
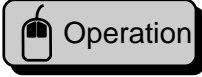

(4) Continuous straight line (V)



This function draws a continuous line.

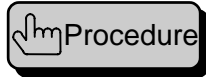

The [Continuous straight line] dialog box appears.
Set attributes for the continuation line.
Specify middle points for the continuation line.
Double-click at the end of the line.



- You can specify middle points up to 50.



- Press and hold the [Shift] key to draw a vertical or horizontal line.

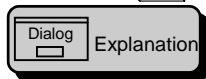

[Continuous straight line]



- ◇ Color (C)
Select a continuation line color in the palette.
 - ◇ Style (S)
Select a type and thickness of the continuation line.
 - ◇ Position (P)
Select a position for the arrow.
 - ◇ Angle (D)
Select an angle for the arrowhead.
 - ◇ Length (L)
Specify the length of the arrowhead in dots. The length of an arrowhead is from 1 to 32 dots.
 - ◇ Link the end points(J)
Marking this check box joins the start and end points of the line.
 - ◇ Tile (T)
Select a tile pattern filling the polygon made when joining of the start and end points.
 - ◇ Forehand (F)
Select a color in the palette for the black portion of the tile pattern.
 - ◇ Back (B)
Select a color in the palette for the white portion of the tile pattern.
- No filling a fan is performed in the following conditions: (1) the fore-color and back-color are transparent, (2) the back-color is transparent in the first tile pattern, and (3) the fore-color is transparent in the second tile pattern.
 - When filling is specified, the start and end points must be joined.
 - When filling is specified, no arrow is drawn.





Click on the 1st dot.

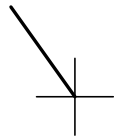
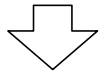

Click on the 2nd dot.

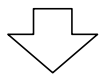

Click on the 3rd dot.

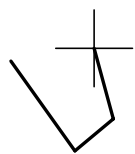
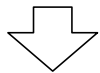

Double-click the last dot.

Press and hold the [Shift] key here.

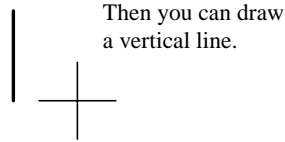

Then you can draw a vertical line.

Click on the 2nd dot.

Press and hold the [Shift] key here.

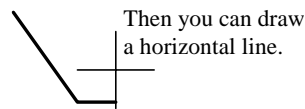

Then you can draw a horizontal line.

Click on the 3rd dot.

When you join the start and end dots.

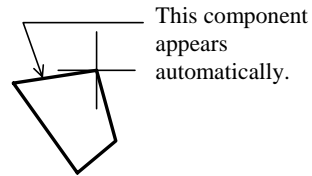

This component appears automatically.

Double-click the last dot.

(5) Spline (W)



Explanation

This function draws a spline (continuation curve).

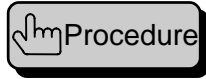

Procedure

The [Spline] dialog box appears.
Set attributes for the spline.
Specify middle points for the spline.
Double click at the end of the line.



Caution

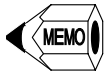

MEMO

- You can specify middle points up to 50.
- While you press and hold the [Shift] key, you can specify a middle point at a vertical or horizontal point from the previous position.



[Spline]

Explanation



- ◇ Color (C)
Select a spline color in the palette.
- ◇ Style (S)
Select a type and thickness of the spline.
- ◇ Position (P)
Select a position for the arrow.
- ◇ Angle (D)
Select an angle for the arrowhead.
- ◇ Length (L)
Specify the length of the arrowhead in dots.
The length of an arrowhead is from 1 to 32 dots.
- ◇ Link the end points (J)
Marking this check box joins the start and end points of the spline.
- ◇ Resolution (I)
Select smoothness of the spline.
Low: Not smooth
High: Smooth
- ◇ Tile (T)
Select a tile pattern filling the figure made when joining of the start and end points.
- ◇ Forehand (F)
Select a color in the palette for the black portion of the tile pattern.
- ◇ Back (B)
Select a color in the palette for the white portion of the tile pattern.
- No filling a fan is performed in the following conditions: (1) the fore-color and back-color are transparent, (2) the back-color is transparent in the first tile pattern, and (3) the fore-color is transparent in the second tile pattern.



Caution

- When filling is specified, the start and end points must be joined.
- When filling is specified, no arrow is drawn.

 Operation

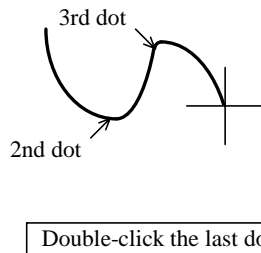
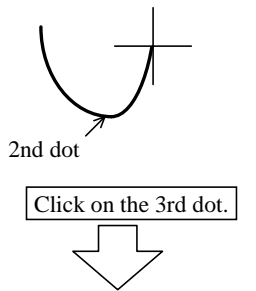
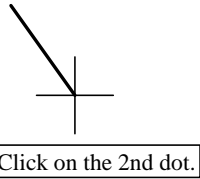
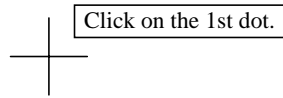

Press and hold the [Shift] key here.

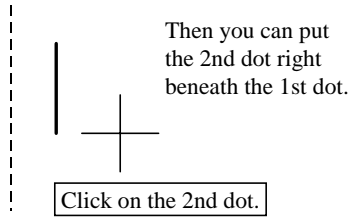

Press and hold the [Shift] key here.

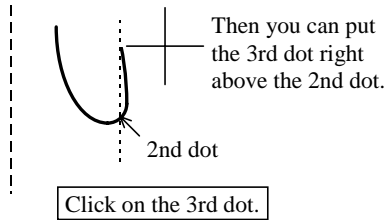

When you join the start and end dots.

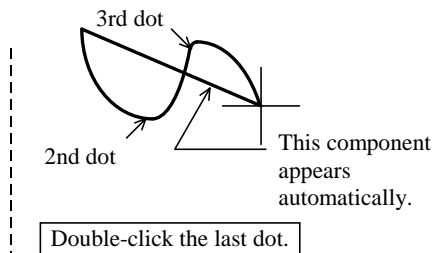

(6) Rectangle (R)

 Explanation

This function draws a rectangle or square.

 Procedure

The [Rectangle] dialog box appears.
Set attributes for the rectangle.
Specify the two points of the diagonal of the rectangle.



- While pressing and holding the [Shift] key, you can draw a square with the second point specified.

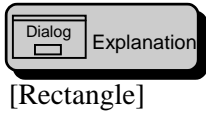

- ◇ Color (C)
Select a frame color for the rectangle in the palette.
- ◇ Style (S)
Select a type and thickness of the frame for the rectangle.
- ◇ Tile (T)
Select a tile pattern filling the rectangle.
- ◇ Forehand (F)
Select a color in the palette for the black portion of the tile pattern.
- ◇ Back (B)
Select a color in the palette for the white portion of the tile pattern.
- ◇ Chamfer (R)
Mark this check box to make the rectangular corners round.
- ◇ Chamfering amount (D)
Specify the chamfering amount with a dot. The value that you can specify is from 1 to 99 (dots).



- No filling a fan is performed in the following conditions: (1) the fore-color and back-color are transparent, (2) the back-color is transparent in the first tile pattern, and (3) the fore-color is transparent in the second tile pattern.

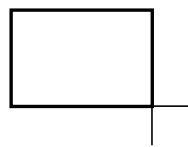
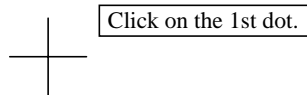
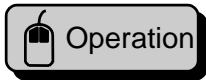

Click on the 2nd dot.

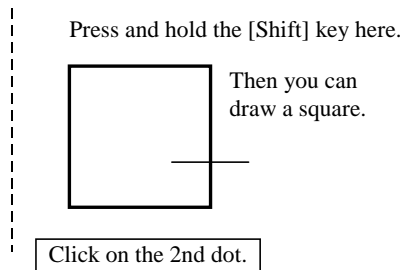

Click on the 2nd dot.

(7) Parallelogram (Q)

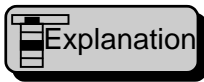

Explanation

This function draws a parallelogram.

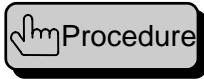

Procedure

The [Parallelogram] dialog box appears.

Set attributes for the rectangle.

The first two dots specify a side making up a parallelogram.

Specify the third dot, which joining the second dot and making up the second side adjacent to the first side for the parallelogram.



- While pressing and holding the [Shift] key, you can draw a square with the second point specified.

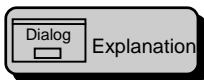

Dialog Explanation

[Parallelogram]



◇ Color (C)

Select a frame color for the parallelogram in the palette.

◇ Style (S)

Select a type and thickness of the frame for the parallelogram.

◇ Tile (T)

Select a tile pattern filling the parallelogram.

◇ Forehand (F)

Select a color in the palette for the black portion of the tile pattern.

◇ Back (B)

Select a color in the palette for the white portion of the tile pattern.



Caution

- No filling a fan is performed in the following conditions: (1) the fore-color and back-color are transparent, (2) the back-color is transparent in the first tile pattern, and (3) the fore-color is transparent in the second tile pattern.

 Operation

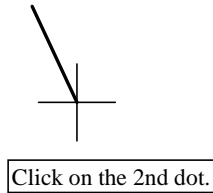
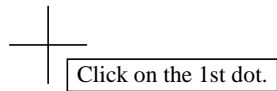

Press and hold the [Shift] key here.

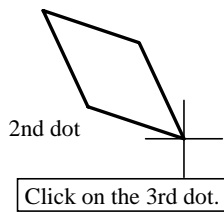
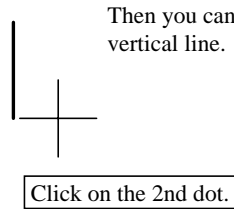

Press and hold the [Shift] key here.

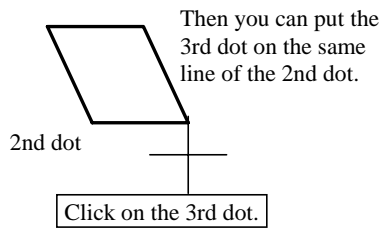

(8) Circle/ellipse (E)

 Explanation

This function draws a circle or ellipse.

 Procedure

The [Circle/Ellipse] dialog box appears.
Set attributes for the circle or ellipse.
Specify two dots representing the diagonal of a rectangle contacting a circle.

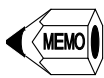

- Press and hold [Shift] to draw a circle.
- Press and hold [Ctrl] and specify the first two dots. Then you can draw a circle with first dot as the center of the circle.

 Explanation

[Circle/Ellipse]



- ◇ Color (C)
Select a color from the palette for the frame of the circle.
- ◇ Style (S)
Select a type and thickness of the frame of the circle.
- ◇ Tile (T)
Select a tile pattern filling the circle.
- ◇ Forehand (F)
Select a color in the palette for the black portion of the tile pattern.
- ◇ Back (B)
Select a color in the palette for the white portion of the tile pattern.



- No filling a fan is performed in the following conditions: (1) the fore-color and back-color are transparent, (2) the back-color is transparent in the first tile pattern, and (3) the fore-color is transparent in the second tile pattern.

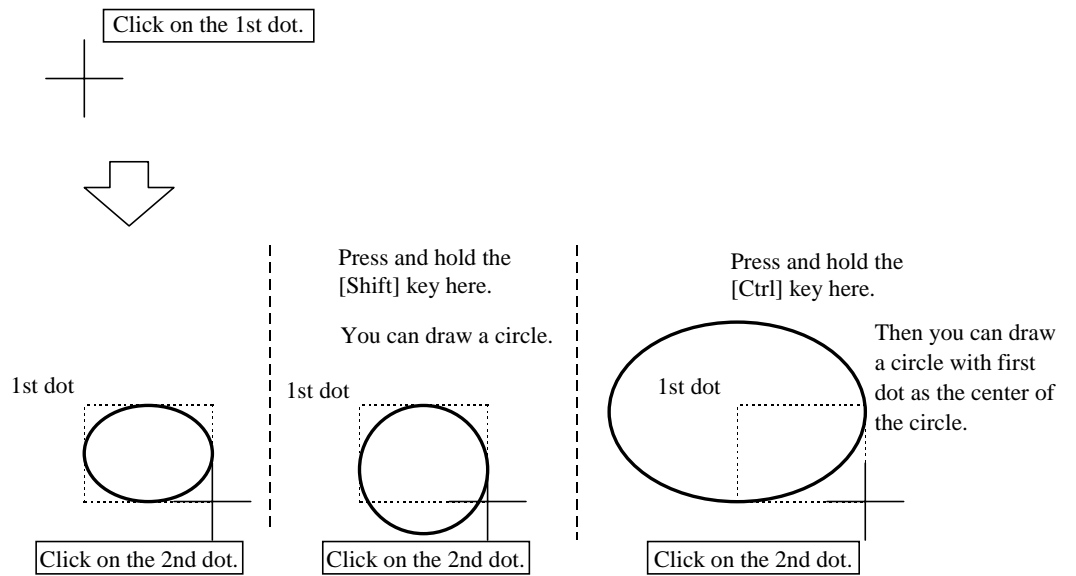
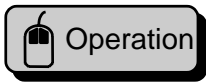

(9) Fill (F)

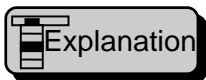

This function paints an area enclosed by the specified boundary color.



The [Fill] dialog box appears.
Set paint attributes.
Specify dots for painting.



- The area to be painted must be drawn with the same palette color.

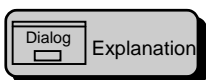

[Fill]



- ◇ Color (C)
Select a color from the palette for the border of the paint.
 - ◇ Tile (T)
Select a tile pattern for painting.
 - ◇ Forehand (F)
Select a color in the palette for the black portion of the tile pattern.
 - ◇ Back (B)
Select a color in the palette for the white portion of the tile pattern.
- No filling a fan is performed in the following conditions: (1) the fore-color and back-color are transparent, (2) the back-color is transparent in the first tile pattern, and (3) the fore-color is transparent in the second tile pattern.

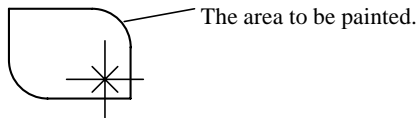
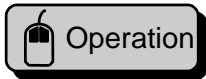

Click on a dot in the area to be painted.

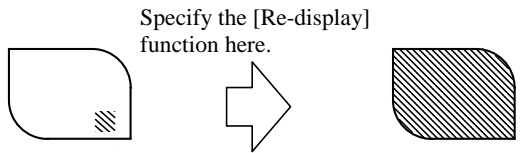

The color does not appear at once.

The color will appear.

* Enter the Re-display function in the menu as: [Edit (E)] - [Re-display (R)]



- It is not recommended to use this function since its editing is difficult. Use other filling patterns instead.



- The borderline must be enclosed; otherwise, the painting color may seep out.
- The color may seep out even if the color is the same if the palette is different.

(10) Characters (S)

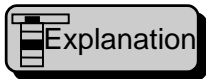

This function allows you to write a character string.



The [Character] dialog box appears.
Set attributes for a character string.
Specify a position where you can put a character string.

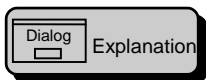

[Character]

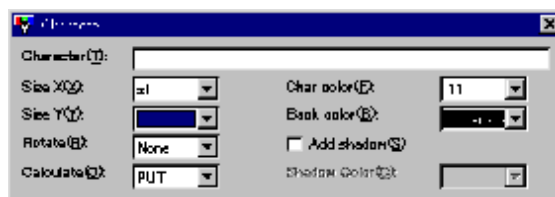

- ◇ **Character(T)**
Enter a character string.
 - ◇ **Size X (X)**
Select a magnification ratio. The character size is 8 and 16 dots for an alphanumeric character and two-byte character, respectively when the magnification ratio is one.
 - ◇ **Size Y (Y)**
Select a magnification ratio. The character size is 16 when the magnification ratio is one.
 - ◇ **Rotation (R)**
Select a rotation angle of text. The rotational direction is clockwise.
 - ◇ **Calculate (O)**
Select a composing method of the text with the background (especially with a pattern).
 - **PUT**
Puts the text on the background as it is.
 - **OR**
Makes a logical sum with the background and color pallet numbers, of which logical sum is the text and background color.
 - **AND**
Makes a logical product with the background and color pallet numbers, of which logical sum is the text and background color.
 - **XOR**
Performs an exclusive OR operation with the background and color pallet numbers, of which XORed sum is the text and background color.
 - **PUT2**
Same as PUT.
 - ◇ **Char color (F)**
Select a text color in the color palette.
 - ◇ **Back color (B)**
Select in the color palette a color for the other components than text in the character string area.
 - ◇ **Add shadow (S)**
Puts a shadow at one dot right below the character string when you mark the check box.
 - ◇ **Shadow color (C)**
Select in the color palette a color of the shadow of the text.
- The shadow of text displayed with Screen Creator 5 is slightly different from that displayed with the OIP.
 - Screen Creator 5 does not perform operations with text for display.



(11) Bitmap (B)



Explanation

This function pastes a bit map.

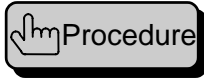

Procedure

The [Bitmap] dialog box appears.

Select a bit map to be pasted.

Set attributes of the bit map.

Specify a position for pasting the bit map.

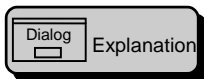

[Bitmap]

Explanation



◇ Name (N)

Enter a bit map name.

◇ Select (S)

The [Select a bit map] dialog box appears, where select a bit map in the bit map library.

◇ Color mode (C)

Select in the color pallet a color for the other component than the black (or transparent) when two-color conversion is made. If you select the transparent color, not two-color conversion is made.

◇ Calculate (O)

Select a composing method for a bit map and its background.

• PUT

The transparent portions of the bit map are made black when you paste it. If the bit map is pasted on the background of a component, its transparent portions are left unchanged.

• OR

Makes a logical sum with the background and color pallet numbers, of which logical sum is the bit map color.

• AND

Makes a logical product with the background and color pallet numbers, of which logical sum is the bit map color.

• XOR

Performs an exclusive OR operation with the background and color pallet numbers, of which XORed sum is the bit map color.

◇ Transparent (T)

Black portions of a bit map are made transparent.

• Screen Creator 5 does not perform operations with bit maps.



Caution

Dialog Explanation
[Select bitmap]

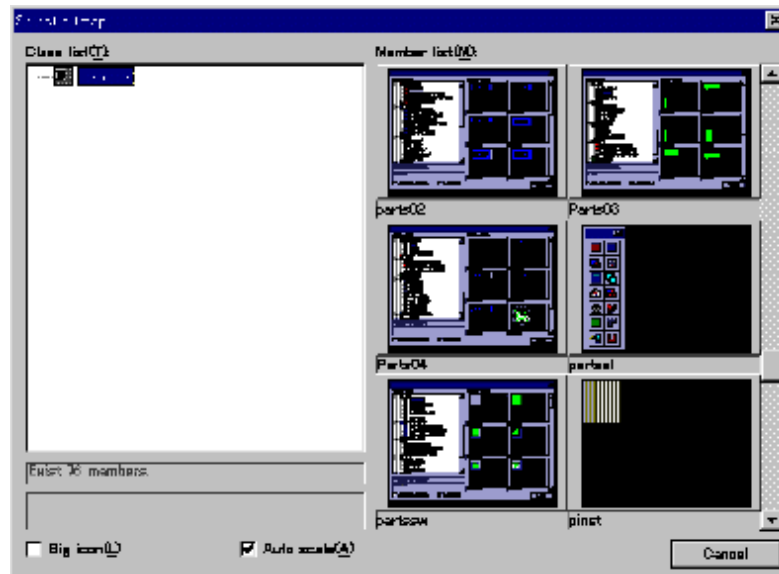

- ◇ Class list (T)
Select a class in which bit maps are stored.
- ◇ Member list (M)
Select a bit map you want to paste among bit maps stored in the selected class.
- ◇ Big icon (L)
Marking this check box allows larger icons in the class list to be displayed.
- ◇ Auto scale (L)
Marking this check box allows an entire bit map to appear in a reduced scale.
- ◇ Cancel
Cancel the bit map selection.

(12) Texture (T)

Dialog Explanation

This function pastes a texture.
You can paste one texture on a matrix.

Procedure

The [Texture] dialog box appears.
Select a texture you want to paste.
Specify attributes of the texture.
Specify a position at which you want to paste the texture.

Dialog Explanation
[Texture]

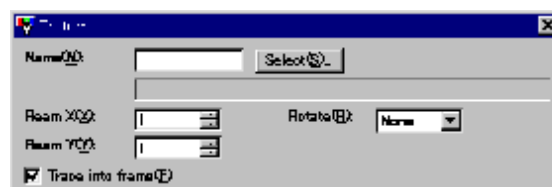

- ◇ Name (N)
Enter a texture name.
- ◇ Select (S)
The [Select texture] dialog box appears where select a texture in a library.

- ◇ Ream X (X)
Specify a repeating count of the texture to be pasted on the matrix in the horizontal direction. You may repeat the pasting is up to 160.
- ◇ Ream Y (Y)
Specify a repeating count of the texture to be pasted on the matrix in the vertical direction. You may repeat the pasting is up to 120.
- ◇ Rotation (R)
Select a rotational angle of the texture. The rotational direction is clockwise.
- ◇ Trace into frame (F)
When this check box is marked, the size of a pattern composing the texture changes in proportion changing the texture size.

Dialog
Explanation
[Select texture]

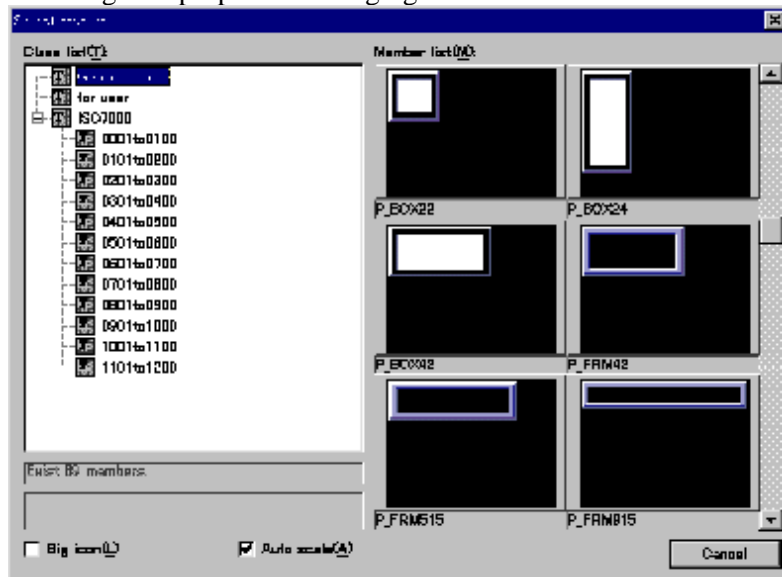

- ◇ Class list (T)
Select a class in which textures are stored.
- ◇ Member list (M)
Select a texture you want to paste among textures stored in the selected class.
- ◇ Big icon (L)
Marking this check box allows large icons in the class list to be displayed.
- ◇ Auto scale (L)
Marking this check box allows an entire texture to appear in a reduced scale.
- ◇ Cancel
Cancel the texture selection.

(13) Macro (M)

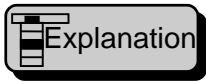

Explanation

A macro draws drawing elements functionally.

1. Circular ruler (C)

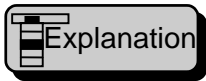

Explanation

This macro puts a circular ruler in combination with straight lines. A scale on the ruler is a straight line.



Procedure

The [Circular scale] dialog box appears.
Set attributes and start drawing.
The [Straight-line] dialog box appears.
Set attributes of the line to be used as scales on the ruler.
Draw inner and outer circles (auxiliary lines).
Specify the start and end angles of scales.



Reference

For more information on the [Straight-line] dialog box, refer to Section 4-2 (2), Straight line.

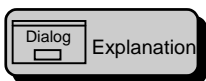

[Circular scale]

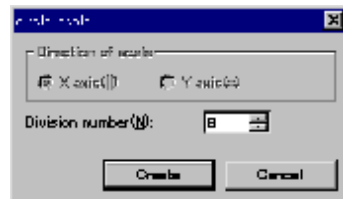

- ◇ Division number (N)
Specify the number of divisions of the ruler. The number of scales is the dividing count plus 1.
- ◇ Create
Starts drawing the ruler.
- ◇ Cancel
Cancel drawing the ruler.

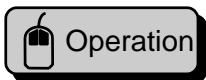

Operation

You want to scale a meter.

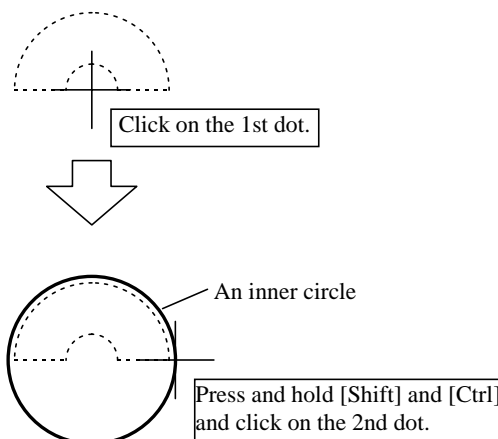



For more information on drawing a circle, refer to Section 4-2 (8), Circle/Ellipse.

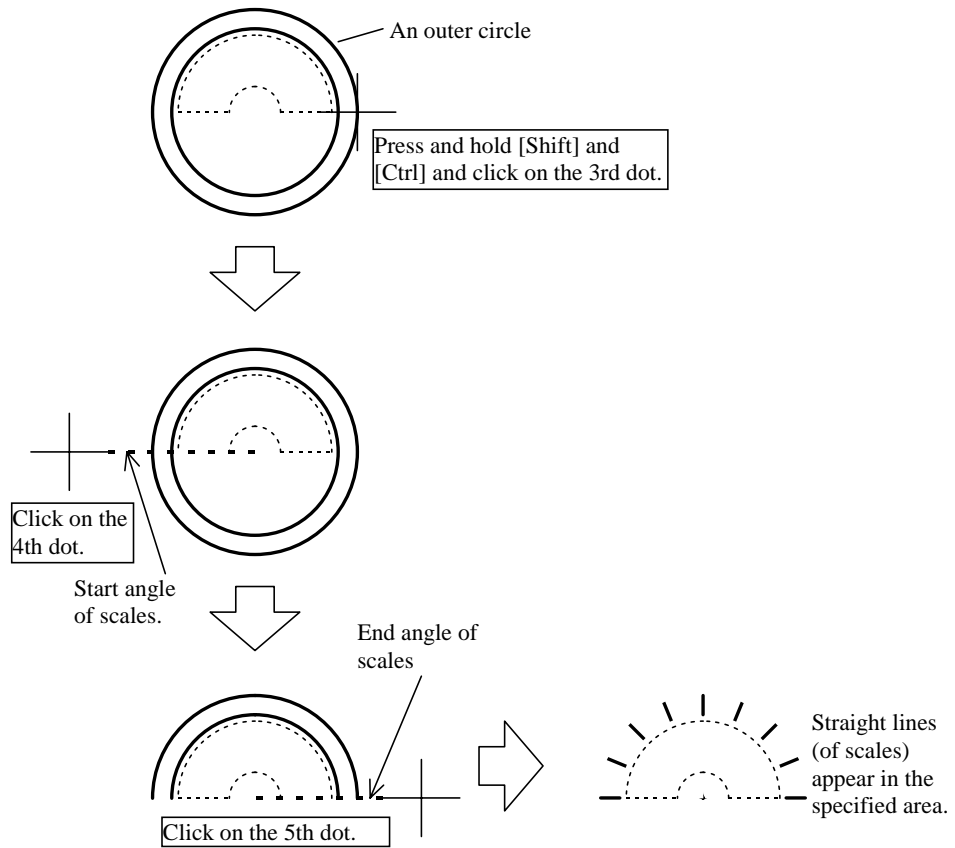

2. Line-shaped scale (L)

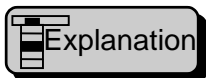

This macro puts a straight ruler in combination with straight lines. A scale on the ruler is a straight line.



- The [Line scale] dialog box appears.
- Set attributes and start drawing.
- The [Straight-line] dialog box appears.
- Set attributes of the line to be used as scales on the ruler.
- Draw rectangular (auxiliary lines) to be the outer frame of the ruler area.



For more information on the [Straight-line] dialog box, refer to Section 4-2 (2), Straight line.

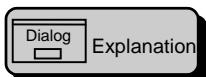

[Line scale]

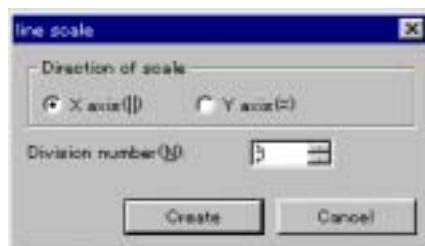

◇ Scale direction

- X-axis (||)
Vertical lines are arranged horizontally. The lines are used as scales on the X-axis.
- Y-axis (=)
Horizontal lines are arranged vertically. The lines are used as scales on the Y-axis.

◇ Division number (N)

Specify the number of divisions of the ruler. The number of scales is the dividing count plus 1.

◇ Create

Starts drawing the ruler.

◇ Cancel

Cancel drawing the ruler.

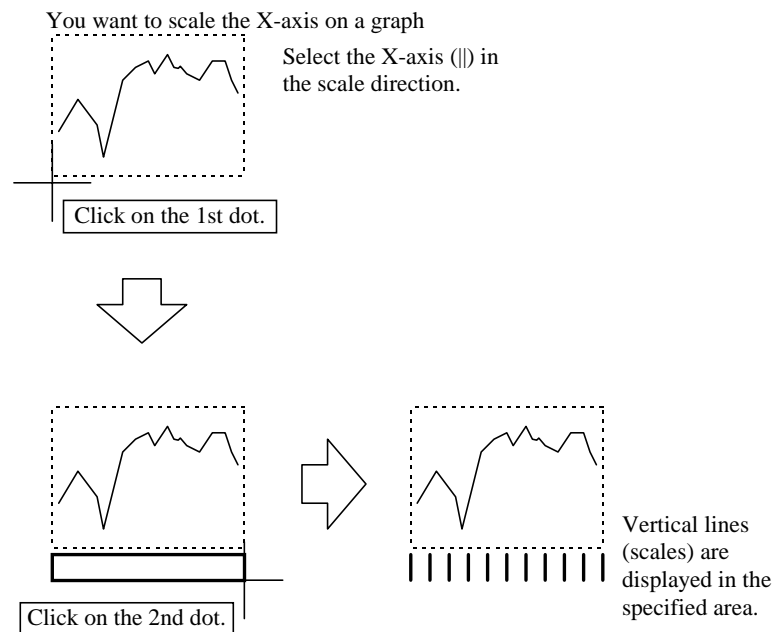
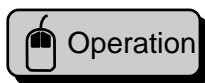

3. Polygon (D)

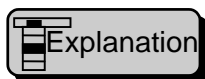

This macro draws a polygon with a continuous line. A polygon once placed is of a continuous line.



- The [Property of polygon] dialog box appears.
Set attributes and start drawing.
- The [Continuous straight line] dialog box appears.
Set attributes of the line to be used as a polygon.
Specify a circle contacting the outer figure of the polygon.
Specify the direction of the polygon.



For more information on the [Continuous straight line] dialog box, refer to Section 4-2 (2), Straight line.

Dialog Explanation
[property of polygon]



- ◇ **Corners (N)**
Specify the number of angles.
- ◇ **Create**
Starts drawing the polygon.
- ◇ **Cancel**
Cancel drawing the polygon.

Operation

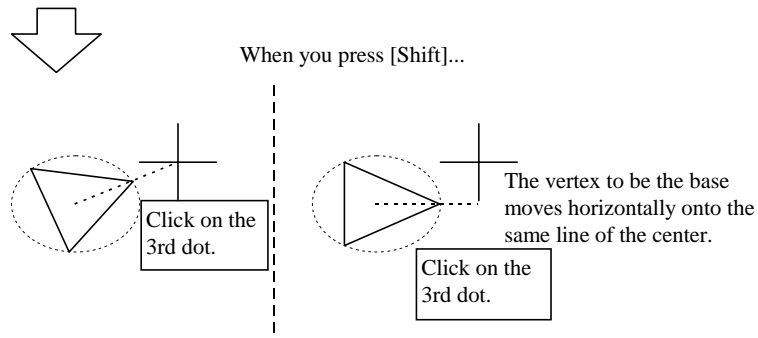
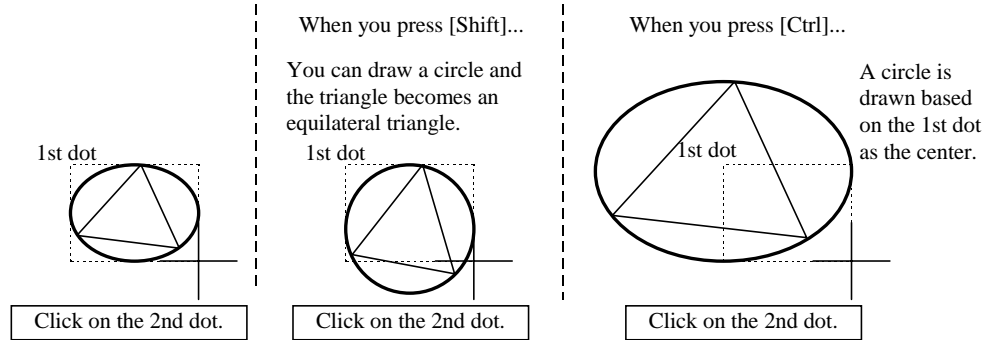
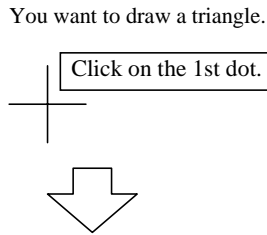

(14) Control (C)

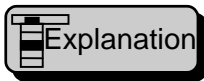

Explanation

This macro places a control on a component.

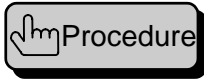

Procedure

A dialog box appears, which is used to set properties for each control.
Set properties for each control.
Specify a position to place a control.



Reference

For more information on controls, refer to Control Reference in Screen Creator 5 User's Manual.

(15) Parts (P)

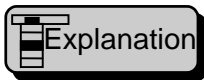

Explanation

This macro places components on a screen.



Procedure

The [Select parts] dialog box appears.
Select a component you want to place on a screen.
The [Property of arrangement parts] dialog box appears.
Set component properties.
Specify a position where you want to place the component.

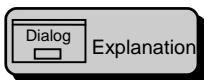

[Select Parts]

Explanation

Select a class of a component to be selected.

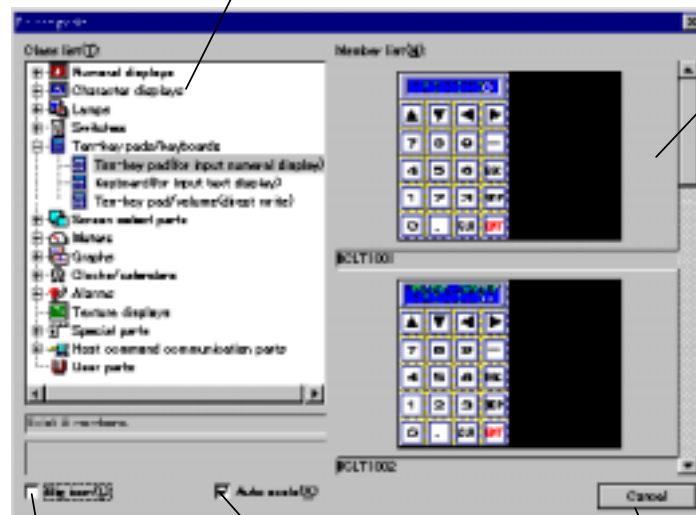

Select a component you want to arrange among components stored in the class.

Icons for a class list become larger.

Marking this check box allows an entire component to appear in a reduced scale.

Cancel the component arrangement.

- ◇ **Class list (T)**
Select a class in which a component to be selected is stored.
- ◇ **Member list (M)**
Select a component you want to arrange among components stored in the selected class.
- ◇ **Big icon (L)**
Marking this check box allows larger icons in the class list to be displayed.
- ◇ **Auto scale (L)**
Marking this check box allows an entire component to appear in a reduced scale.
- ◇ **Cancel**
Cancel the component arrangement.

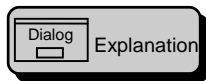

[Property of arrangement parts]

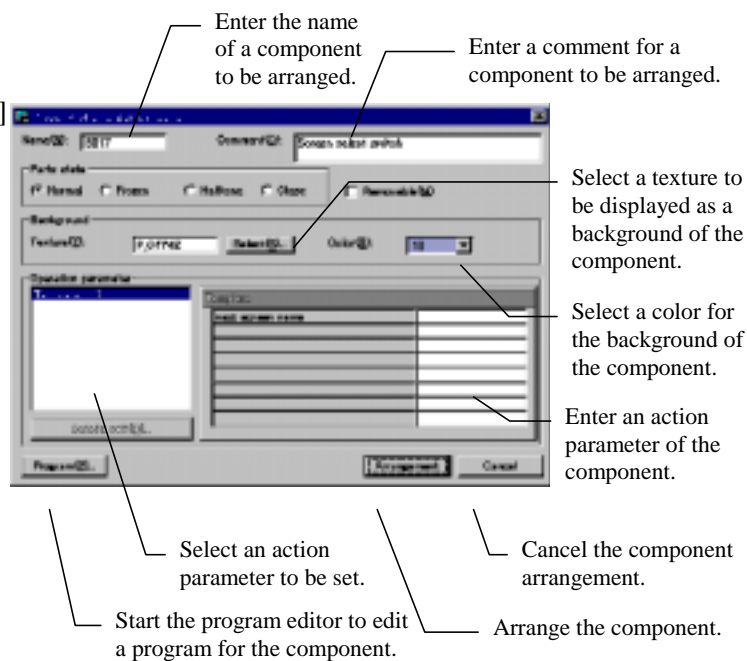

- ◇ **Name (N)**
A name is an identifier to distinguish a component from others in the screen. The name must consist of up to eight letters. There is no difference between the uppercase and lowercase letters.
 - A component name must be unique within a screen. In other words, you can use the same name in different screens.
- ◇ **Comment (C)**
Comments on standard components have already been entered. For a user-defined component, the comment given at storing the component into the library has been entered.



◇ Parts state

Select initial status of a component when it is arranged on the screen.

• Normal

A component is arranged on the screen as it is. In this state, you can display data and enter switches as well.

• Frozen

A component is displayed as it is. In this state, you can display data but cannot enter switches.

• Halftone

A component is displayed in half tone (in shade). You can neither display data nor enter switches.

• Close

No component is displayed on the screen. Thus you can neither display data nor enter switches.



- If arranging a component in the close condition, you must make it movable.

◇ Removable (M)

Marking this check box allows you to move a component.



- If closing or moving a component, you must make it movable first.
- Before you put a component on another one for arrangement, be sure to make it movable.
- If a component is arranged in the movable condition, the processing speed becomes lower. It is not recommended to make a component movable if you do not plan to move or close.
- All the components arranged in the global screen are made movable.

◇ Operation parameter

Enter parameters.



For more information on the action parameters for standard components, refer to component manuals.

◇ Program (P)

For more information on the editor ([Program] dialog box), refer to Section 4-3 (10), Attributes/Change properties.



4-3 Editing (E) — At Drawing —

(1) Undo (U)

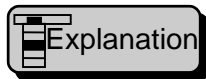

This function is used to undo operations in editing.



- This function is effective for the latest 16 operations.

(2) Redo (W)

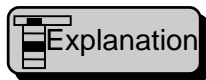

This function is used to cancel the immediately previous Undo operation.

(3) Cut (T)

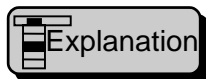

This function is used to copy a selected element onto the clipboard and delete it.

(4) Copy (C)

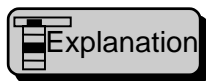

This function is used to copy a selected element onto the clipboard.

(5) Paste (P)

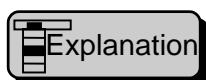

This function is used to copy onto a specified position an element that has been copied on the clipboard. The element copied on the clipboard is not intact until another element is copied on it.

(6) Delete (D)

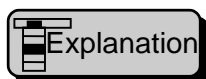

This function is used to delete a selected element.



- Pressing the Delete key causes the same effect.

(7) Select all (A)

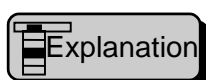

This function selects all elements on the currently opened window in the selecting state.

(8) Refresh(R)

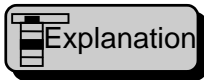

Explanation

This function re-draws an entire screen on the currently opened window.

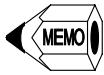

- This function is effective when coloring is made or color (figure) is distorted in scrolling.
- When the number of colors is smaller than 256 on a Windows screen, colors of the color palette may be transformed. Executing this function allows the distorted or transformed colors to be restored.

(9) Corner (Z)

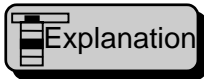

Explanation

This function changes a box selection to a vertex selection. In the box selection, you may change the size of an entire element. On the other hand, in the vertex selection, you may change the vertex position instead of the entire figure.

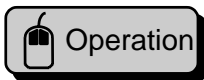

Operation

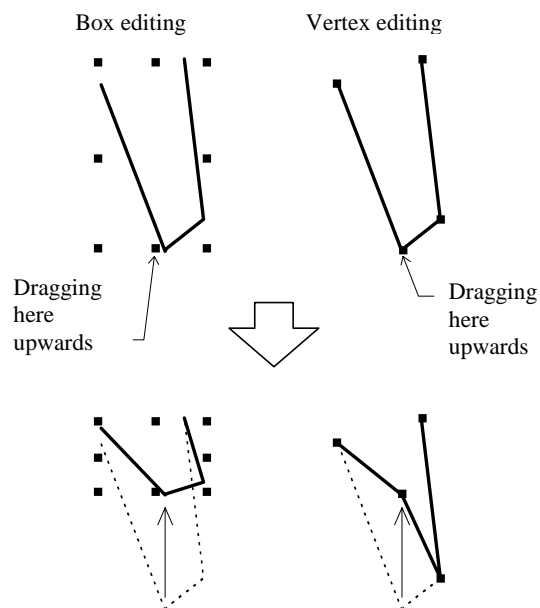

- You can edit the following elements in the vertex editing: arc, continuous line, spline, parallelogram, meter, and pipe.

(10) Change attributes of properties (E)

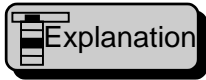

This function opens a dialog for editing a selected element, attributes, or properties.

- When a figure is selected, this function opens a dialog for its attributes.
- When an element is selected, this function opens a dialog for its properties.
- When a control is selected, this function opens a dialog for its control.



For you to change fire attributes, refer to Section 4-2, Create.

For changing control properties, refer to Control Reference in Screen Creator 5 User's Manual.

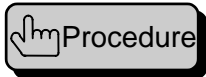

This section presents the procedure for changing arranged component properties.

The [Property of arrangement parts] dialog box appears.
Set attributes.

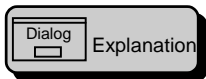

[Property of arrangement parts]

Set the initial state to the arranged component.

Give the arranged component a name

Enter a comment for the arranged component.

Marking this box allows the component movable. (The component becomes a movable component.)

Specify a texture for the background of the arranged component.

Specify a background color for the arranged component.

Display the selected action parameter. When activating this box, you can specify an action parameter.

Open the editing dialog for the selected control.

Open the dialog for entering the arranged component program.

Open the window for editing contents for the arranged component.

- ◇ OK
Fix changed contents.
- ◇ Cancel
Cancel changed contents.

For more information on action parameters, refer to Control Reference in Screen Creator 5 User's Manual.



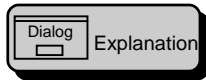

[Program]

Explanation

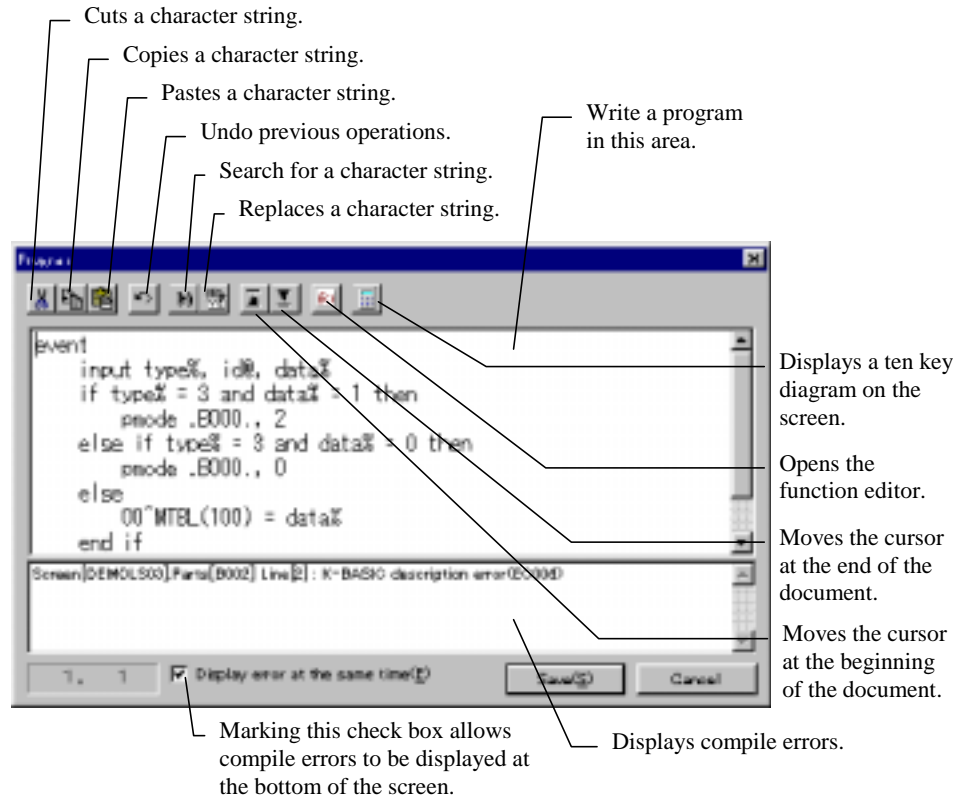

For more information on the function editor, refer to Section 4-4 (11), Function Library.

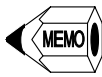

- When more than one element is selected, the dialog opens in succession.
- When an element is double-clicked, a dialog for changing attributes or properties is also opened.

(11) Edit component of parts (H)

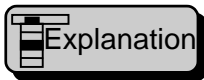

This function opens a window for editing the selected component.

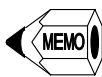

- If the editing window has been open already, the [Edit component contents] menu does not appear with a component selected on the screen. In this case, it is a wise way to minimize the screen window to put the editing window for the component in the front.

(12) Change order (O)

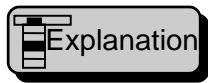

This function changes the displaying order of selected elements.



- You cannot move a figure in the front of components and controls.
- You cannot move a fixed component in the front of movable components.
- Grouped components are moved in a unit of a group.

1. Move to front (F)



This function moves the displaying order for selected elements in the front (on the topmost).

2. Move to back (B)

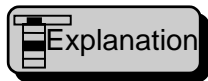

This function moves the displaying order for selected elements at the back (on the bottom).

(13) Rotation/mirror (M)

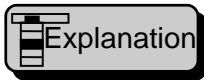

This function rotate or mirror a selected figure but does not a bit map.

1. Rotate 90 degrees(A)

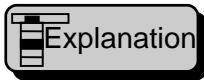

This function rotates a selected figure 90 degrees.

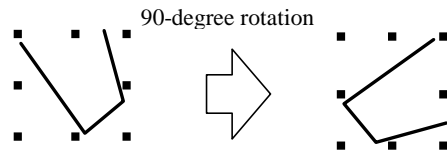

2. Rotate 180 degrees (B)

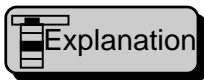

This function rotates a selected figure 180 degrees.

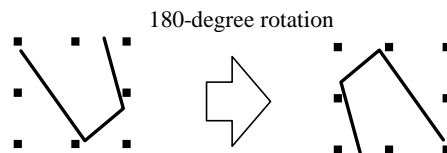

3. Rotate 270 degrees (C)

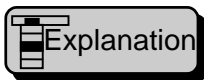

This function rotates a selected figure 270 degrees.

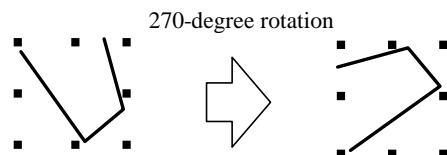

4. Horizontal mirror (X)

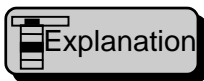

This function mirrors a selected figure with the Y-axis of symmetry.

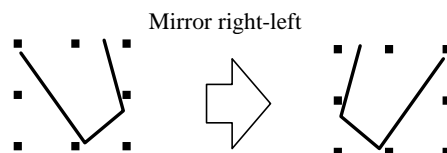

5. Vertical mirror (Y)

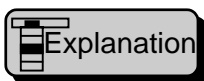

This function mirrors a selected figure with the X-axis of symmetry.

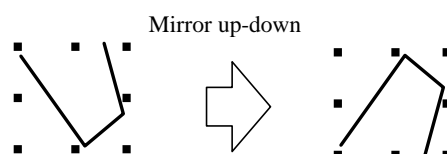

(14) Group parts (G)

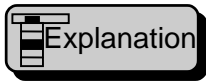

This function groups some selected components or cancels the grouping of elements. Grouped elements can be opened or closed at the same time. You can make some selected components as child components and can create their parent that has an realm enclosing its children. The grouped components are made movable and can be moved in a unit of group.

1. Group parts (G)

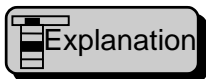

This function groups some selected components.



Select components you want to group.
 Select [Edit] - [Group parts] - [Group parts] functions.
 The [Group parts] dialog box appears.
 Set attributes.

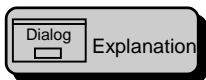

[Group parts]

The screenshot shows the 'Group parts' dialog box with the following annotations:

- Set the initial state for grouped components. (points to the 'State of group' section)
- Specify a group name. (points to the 'Name' field)
- Enter a comment for the group. (points to the 'Comment' field)
- Grouped components are always made movable. (points to the 'Movable' checkbox)
- Select a background color. (points to the 'Color' dropdown)
- Specify a margin for a new component. (points to the 'Margin' section)
- Specify a texture for the group. (points to the 'Texture' field)
- Marking this check box allows the selected background to be copied for making it the background of the parent component. (points to the 'Copy selected background of screen to background of group' checkbox)

- ◇ OK
Fix settings.
- ◇ Cancel
Cancel the grouping components.

2. Release parts group (U)

This function cancels grouping of selected components. Executing this function displays a message. When you agree with the canceling, click [OK].

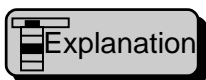

- When you cancel grouping of a parent component, the group of its child components is also canceled.
- The group of child components is canceled; it does not affect any groups.
- The parent component remains as a normal component independently if its group is canceled. You can delete on an as needed basis.

(15) texture expansion (S)

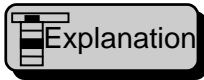

Explanation

This function rolls out a selected texture on a screen or component and a background texture of a component in order to change it into a figure.

1. Selected texture (S)

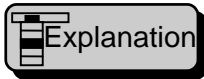

Explanation

This function rolls out a selected texture on a component and changes it into a figure.

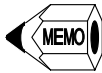

- The rolled out texture is deleted from the screen or component.
- The resultant figure can be edited like a normal figure.

2. Parts background texture of a component (B)

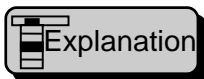

Explanation

This function rolls out a background texture of a component and changes it into a figure.

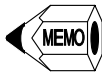

- A menu is made effective in editing contents of a component.
- The rolled out background texture will disappear.
- The resultant figure can be edited like a normal figure.

(16) Edit screen program (B)

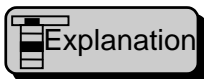

Explanation

An editing window for a screen program is open in editing a screen on a selected window. An editing window for a component program is open in editing a component.



Reference

For more information on program editing, refer to K-Basic Program Descriptions in Screen Creator 5 User's Manual.

(17) Edit operation parameter (V)

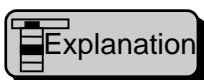

Explanation

This function opens a window in editing templates and action parameters in a list form on the selected window (screen or component editing).



Reference

For more information on action parameter editing, refer to Section 4-3 (10), Change Attributes/Properties.

4-4 Editing (E) — At Writing a Program —

(1) Undo (U)

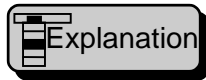

This function is used to undo the operation only once in editing (cut or paste). This function is used to cancel the immediately previous Undo operation.



- In writing a program, you can perform the undo operation only once.

(2) Cut (T)

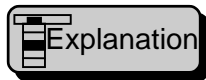

This function is used to copy a selected element onto the clipboard and delete it.

(3) Copy (C)



This function is used to copy a selected range onto the clipboard.

(4) Paste (P)

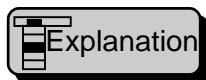

This function is used to copy onto a specified position in editing a text that has been copied on the clipboard. The text copied on the clipboard is not intact until another element is copied on it.



- You may copy elements in another application (such as Memo Pad and Word Pat) onto the clipboard.

(5) Delete (D)

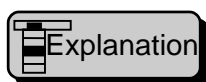

This function is used to delete a selected range.



- Pressing the Delete key causes the same effect.

(6) Select all (A)

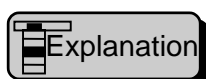

This function selects all texts on the window currently open.

(7) Find (F)

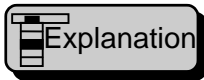

Explanation

This function searches for a character string in a program.

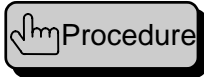

Procedure

The [Find] dialog box appears.

Enter a character string to be searched for.

Marking the [Find a word] check box performs the searching operation only when a searching text is entered in a unit of words.

Marking the [Discriminate uppercase and lowercase] check box allows uppercase letters to be distinguished from lowercase letters.

Specify the searching direction from the current cursor position, upwards or downwards.

Click on the [Start find] push button for starting the search operation.

In the searching operation, the [Finding] dialog box appears.

Click on the [Continue downward] push button to go on downwards the search operation from the current cursor position.

Click on the [Continue upward] push button to go on upwards the search operation from the current cursor position.

When the objective text is not found in the searching operation in the specified direction, a message appears and the operation ends.

Click on the Cancel button to cancel the searching operation.

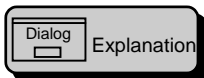

[Find]

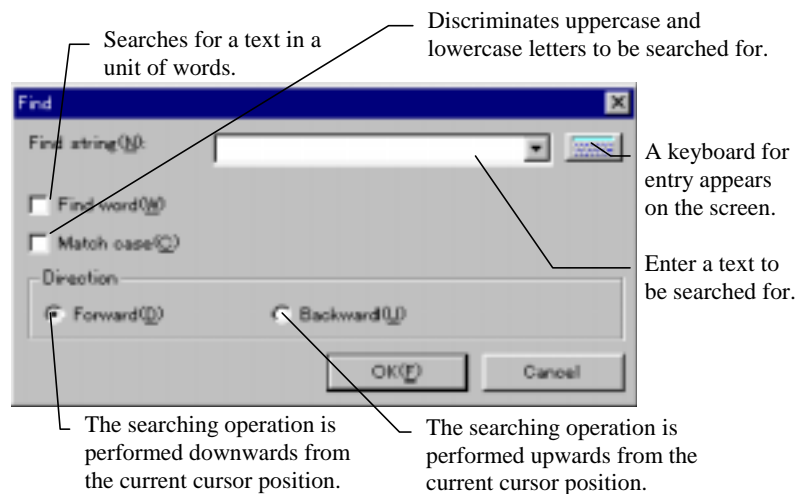

[Finding]

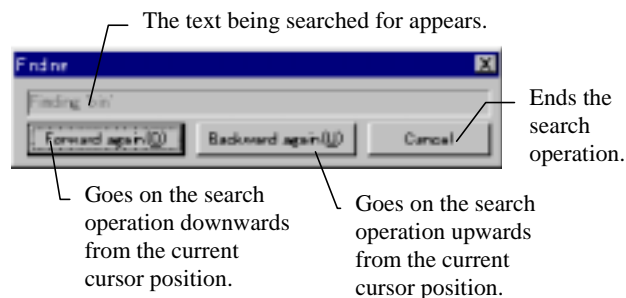

- Clicking on the keyboard figure on the screen allows you to enter a text through it on the screen.

(8) Replace (E)

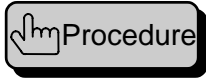
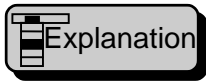

This function replaces a text in a program.

The [Replace] dialog box appears.

Enter texts in the [Find what] and [Replaced text] boxes.

Marking the [Find a word] check box performs the searching operation only when a searching text is entered in a unit of words.

Marking the [Discriminate uppercase and lowercase] check box allows uppercase letters to be distinguished from lowercase letters.

Specify the searching direction from the current cursor position, upwards or downwards.

Clicking on the [Replace all] push button replaces all objective texts to be replaced unconditionally. Then, the number of replaced texts appears before the end of the operation.

Every time you click on the [Start replace] push button, the objective text is replaced.

In the replacing operation, the [Replacing] dialog box appears.

Click on the [Skip and continue] push button not to replace the currently displayed text and to go on the searching operation downwards.

Click on the [Skip and continue] push button not to replace the currently displayed text and to go on the searching operation upwards.

Click on the [Replace and continue] push button to replace the currently displayed text and to go on the searching operation downwards.

Click on the [Replace and continue] push button to replace the currently displayed text and to go on the searching operation upwards.

When the objective text is not found in the searching operation in the specified direction, a message appears and the operation ends.

Click on the Cancel button to cancel the replacing operation.

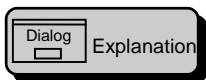

[Replace]

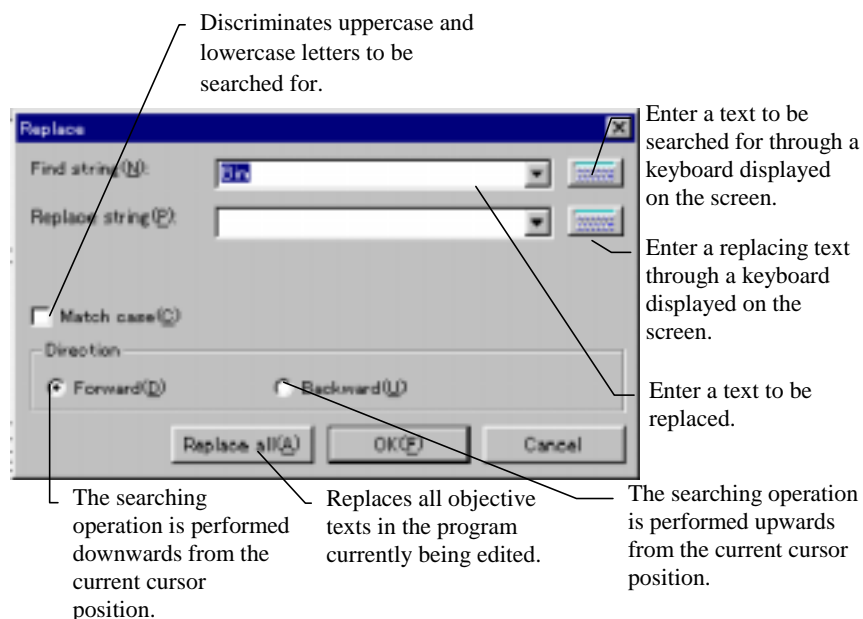



Explanation

[Replacing]

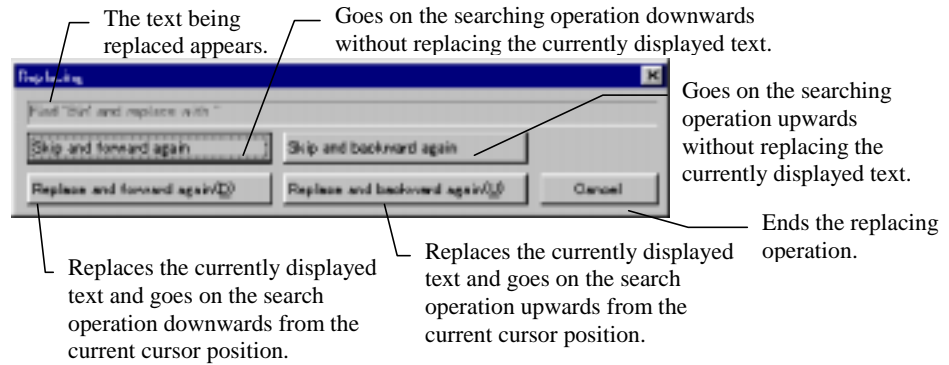

Caution

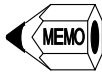

- Performing the replacing with the [Select all] option replaces all searched texts unconditionally. Note that the [Undo] function is effective only for the last one.
- Clicking on the keyboard figure on the screen allows you to enter a text through it on the screen.

(9) Go to top (S)

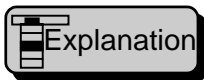

Explanation

This function puts the cursor at the beginning of the document.

(10) Go to end (L)

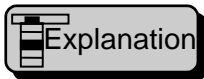

Explanation

This function puts the cursor at the end of the document.

(11) Function library (X)

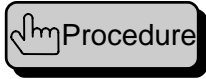
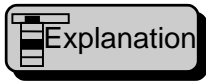

This facility is used to create a function and edit an existing one.

The [New function] dialog box appears.

Click on the [Open] button to edit an existing function.

The [Open function] dialog box appears. Select a function you want to edit and click on [OK]. Then, the [New function] screen appears again.

Clicking the [Save] button saves the function being edited.

The [Open function] dialog box appears again. Then click on [OK] when you want to save it.

Clicking on the [cancel] button cancels the saving.

Clicking on [OK] before saving on the create screen causes a message to appear.

If you want to cast away contents of the editing, click on [OK].



- Clicking on [OK] before saving causes a message to appear in order to confirm that you want to cast away edited contents. If you want so, click on [OK].

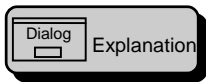

[New function]

Creates a new function.

Opens an existing function.

Saves a function being edited.

Cuts a text.

Copies a text.

Pastes a text.

Undo the previous operation (only once).

Displays a comment for a function being edited.

Write contents of a function.

```

Function BcdBinConvert$(mode$,data$)
  if mode$ = 2 then
    if data$ >= &H8000 then data$ = data$ - &H10000
  else if mode$ = 3 then
    data$ = bcd2bin(data$)
  end if
  BcdBinConvert$ = data$
end function
    
```

Screen[DEMOL500] Pane[0002] Line[2] : K-BASIC description error(E0004)

Display error at the same time(E)

OK

Marking this check box allows compile errors to be displayed at the bottom of the screen.

Displays compile errors.

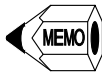
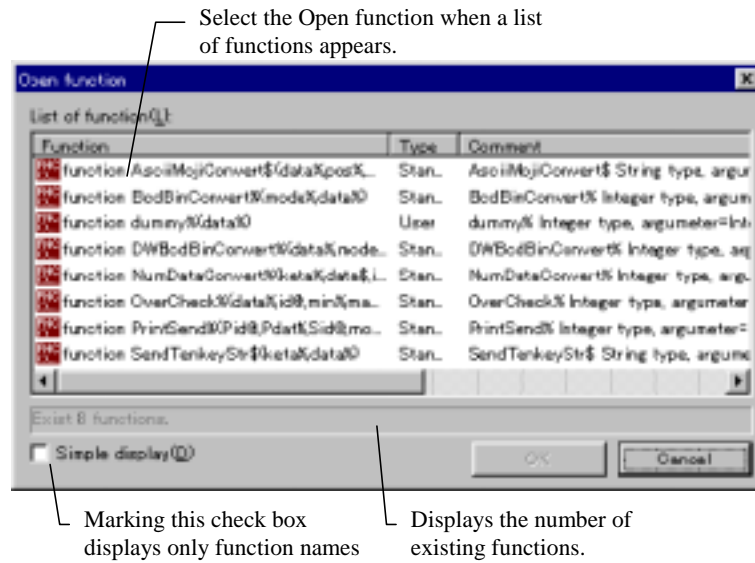
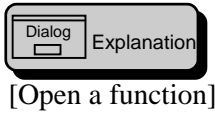

- If deleting a created function, open the function and erase its all contents and save it once. When a message telling "Do you want to delete the function" appears, click on [OK].



For more information on creating a function, refer to K-Basic Program Descriptions in Screen Creator 5 User's Manual.

4-5 Library (L)

(1) New(N)

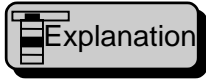

This facility creates a library component and library texture.

1. Parts (P)

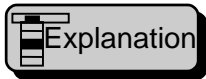

This function opens a new window to create a library component. In the initial state, the component area is maximized (full screen size).

2. Texture (T)

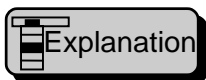

This function opens a new window to create a texture. In the initial state, the texture area is maximized (full screen size).

(2) Open (O)

1. Parts (P)

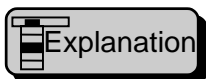

This function opens a new window to edit a library component.



The [Open Parts] dialog box appears.

Select a library component class where a component to be edited is accommodated.

When a component is selected in the member list, the editing window is opened.

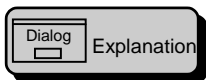

[Open parts]

Select a library component class.

The editing screen appears when a component is selected.

Displays the number of component members accommodated in the selected class.

Displays a comment on the selected component.

Marking this check box allows icons to be larger.

Marking this check box allows an entire member list to appear in a reduced scale.

2. Texture (T)

This function opens a new window to edit a library texture.

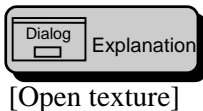
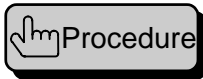

[Open texture]

The [Open texture] dialog box appears.

Select a library texture class where a texture to be edited is accommodated.

When a texture is selected in the member list, the editing window is opened.

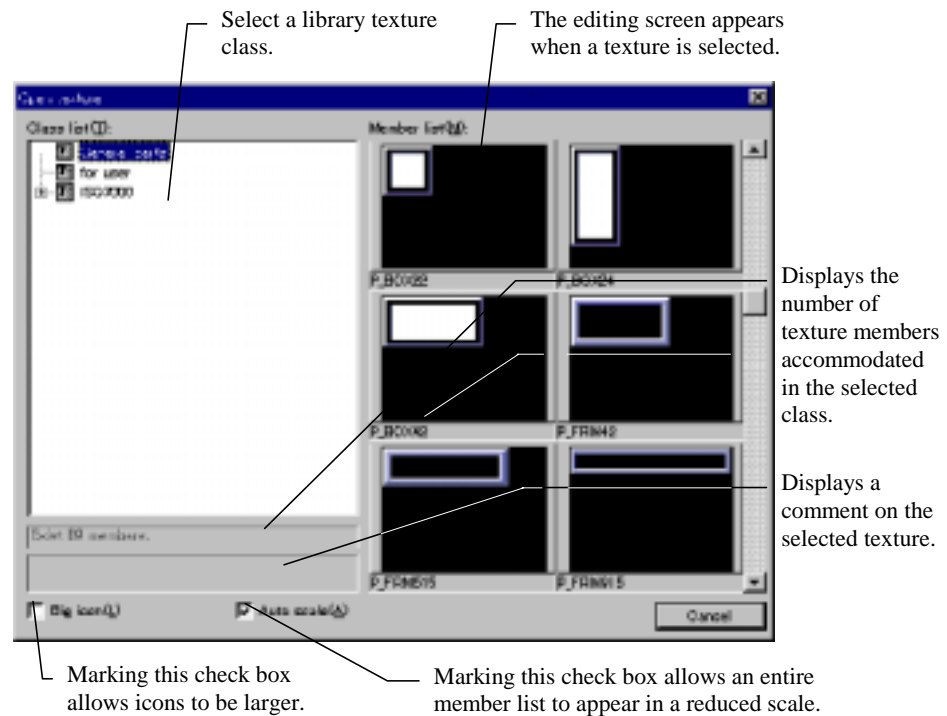

(3) Close (C)

This function closes a window for a library component or library texture being edited. When changes have been applied to it, a dialog box appears to confirm that the changes are to be saved.

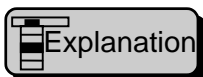

When you have made some changes to a library component or texture, a dialog box appears to verify that the changes are saved. To save them, select [Yes].

If no changes have been applied, the window is closed immediately.

- If you save an edited standard component, the original component is replaced with the changed one. You are recommended that the changed component be saved with another name.



(4) Save (S)



This function saves a library component or texture being edited.

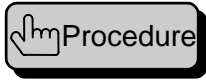

The [Save parts] or [Save texture] dialog box appears.
 Select a class in which a component or texture is saved.
 Enter a name for the edited component or texture.
 Enter a comment of the component or texture.
 Specify the folder name and file name to accommodate the component or texture.
 Select an icon for the component (component library only).
 Specify an entry number when the texture is to be recorded.
 Specify an area (size) for the component or texture.
 Confirm the above specifications and click on [OK].

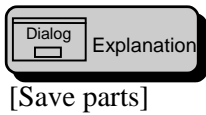

[Save parts]

Select a class for the saving.

A list of members of the selected class

Enter a name for the edited component.

Enter a comment on the component.

Specify a folder and the name of a file to accommodate the component.

Select the icon for the component.

Specify a range for the component.

Marking this check box displays only names in the member list.

Marking this check box allows icons to be larger.

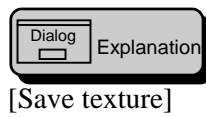

[Save texture]

Select a class for the saving.

A list of members of the selected class appears.

Enter a name for a texture to be saved.

Enter a comment on the texture.

Specify a folder and the name of a file to accommodate the texture.

Specify an entry number.

Specify a range for the texture.

Marking this check box displays only names in the member list.

Marking this check box allows icons to be larger.

(5) Property of member (P)

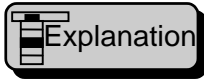

Explanation

This function opens a window in which you can enter properties for library component of texture being edited.

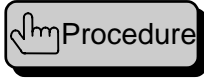

Procedure

The [Property of library parts] or [Property of library texture] dialog box appears.

The name, comment, and file name for a component or texture appear.

Specify the area for saving with the left upper and right lower coordinates.

Specify the background texture for the component and the background color (library component only).

Confirming the above specifications and click [OK].

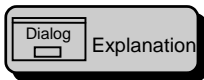

[property of library parts]

Explanation

The screenshot shows the 'Property of library part' dialog box. It contains the following fields and callouts:

- Name:** BCLN1001 (Callout: Displays a library component name.)
- Comment:** Numeral display (Callout: Displays a comment on the library component.)
- File name:** C:\ENG_SM5\LIB\APT\BCLN1001.APT (Callout: Displays the file name for the library component.)
- Saving area:**
 - LeftTop(S):** X: 0, Y: 0 (Callout: Specify the area for saving with the left upper and right lower coordinates.)
 - RightBottom(B):** X: 79, Y: 29 (Callout: Displays the component size.)
 - Size:** X: 80, Y: 30 (Callout: Displays the component size.)
- Background:**
 - Texture(T):** P_FRM42 (Callout: Specify a texture to be used for the background.)
 - Color(B):** 12 (Callout: Specify the background color.)



[Property of library texture]

Explanation

The screenshot shows the 'Property of library texture' dialog box. It contains the following fields and callouts:

- Name:** P_LM92 (Callout: Displays a library texture name.)
- Comment:** (Callout: Displays a comment on the library texture.)
- File name:** C:\ENG_SM5\LIB\TEXT\P_LM92.TEX (Callout: Displays the file name for the library texture.)
- Saving area:**
 - LeftTop(S):** X: 0, Y: 0 (Callout: Specify the area for saving with the left upper and right lower coordinates.)
 - RightBottom(B):** X: 179, Y: 39 (Callout: Specify the area for saving with the left upper and right lower coordinates.)
 - Size:** X: 180, Y: 40 (Callout: Displays the component size.)

(6) Print library member (L)



A library component being edited and the library texture background are stored in a bit map file, and a control list, action parameter, and program are in a text file.

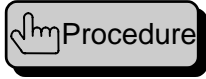

The [Print library parts] or [Print library texture] dialog box appears. Marking the [Save a background] check box allows the background to be written into a bit map file. Specify the destination for the background. Marking the following check boxes allows their contents to be saved in one text file. The check boxes are [Save a control list], [Save an action parameter], and [Save a program]. Specify the destination for the information (library component only). Confirm the above specifications and click on [OK].

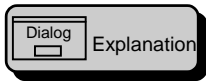

[Print library parts]

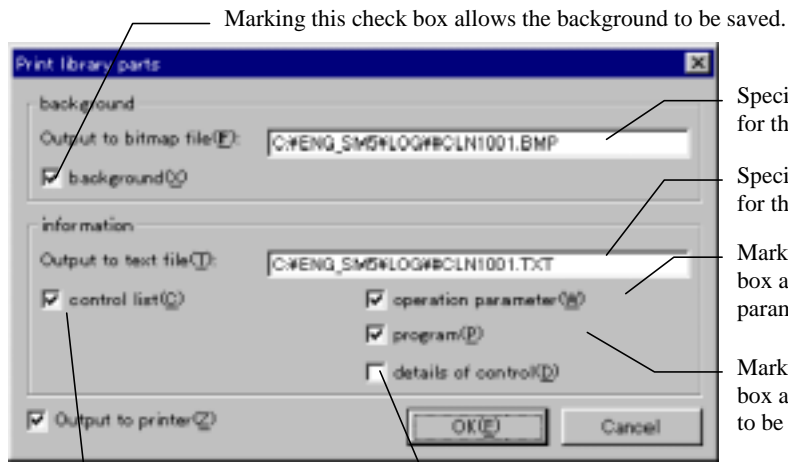

- Marking this check box allows the background to be saved.
- Specify the destination for the background.
- Specify the destination for the information.
- Marking this check box allows an action parameter to be saved.
- Marking this check box allows a program to be saved.
- Marking this check box allows a control list to be saved.
- Marking this check box allows control details to be saved.

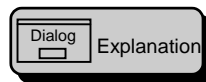

[Print library texture]



- Marking this check box allows the background to be saved.
- Specify the destination for the background.

(7) Add parts through screen (V)

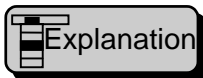

Explanation

This function adds a component created on the screen into a library. When on the screen you select a component to be added to a library, then select a menu.

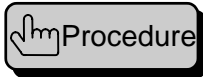

Procedure

The [Save parts] dialog box appears.
 Select a class in which a component is saved.
 Enter a name for the component to be added.
 Enter a comment of the component.
 Specify the folder name and file name to accommodate the component.
 Select an icon for the component.
 Specify an area (size) for the component.
 Confirm the above specifications and click on [Save].

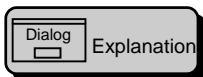

Dialog Explanation

[Save parts]

Displays a class for the saving.

A list of members of the selected class appears.

Enter a name for the component to be saved.

Enter a comment on the component.

Specify a folder and the name of a file to accommodate the component.

Marking this check box displays only names in the member list.

Marking this check box allows icons to be larger.

Name	Comment
BOLN1001	Numerical display
BOLN1002	Numerical display
BOLN1003	Numerical display
BOLN1004	Numerical display
BOLN1005	Numerical display
BOLN1006	Numerical display

(8) Add from external file (A)

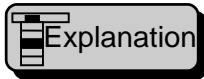

Explanation

This menu is used to add to the current library a component file or a texture file created in another project. You can also use this menu to add a bit map file created in another application to the current library.

1. Component (P)

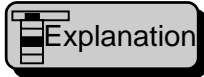

Explanation

This function adds a component created in another project to the current library.

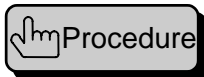

Procedure

The [Add parts] dialog box appears.

Select a class in which a component is added.

Specify a source component file.

Marking the [Copy to the library folder for use] check box copies the source file to the library folder before use. Specify the component file name to be added in the [File name] box.

Enter a component name to be added.

Confirm the above specifications and click on [Add].

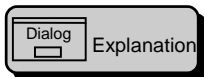

Dialog Explanation

[Save parts]

Displays a class for the adding.

A list of members of the selected class appears.

Specify a source component file.

Marking this check box copies the source file to the library folder before use.

Specify a component name to be added.

Specify a component file name to be added.

Marking this check box allows icons to be larger.

Marking this check box displays only names in the member list.

2. Texture (T)

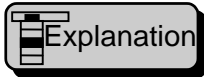

Explanation

This function adds a texture created in another project to the current library.

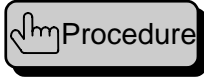

Procedure

The [Add texture] dialog box appears.
 Select a class in which a texture is added.
 Specify a source texture file.
 Marking the [Copy to the library folder for use] check box copies the source file to the library folder before use. Specify the texture file name to be added in the [File name] box.
 Enter a texture name to be added.
 Confirm the above specifications and click on [Add].

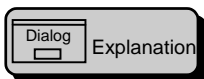

Dialog Explanation

[Save texture]

The screenshot shows the 'Add texture' dialog box with the following callouts:

- Class list:** Displays a class for the adding.
- Member list:** A list of members of the selected class appears.
- Original texture file:** Specify a source texture file.
- Copy to library folder:** Marking this check box copies the source file to the library folder before use.
- Saving method:** Specify a texture name to be added.
- Simple display:** Marking this check box displays only names in the member list.
- Big icon:** Marking this check box allows icons to be larger.
- File name:** Specify a texture file name to be added.

3. Bitmap (B)

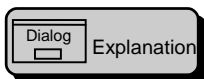
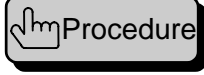
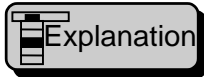

This function adds a bit map file (*.bmp) created in another application to the current library.

The [Add bitmap] dialog box appears.
 Select a class in which a bit map is added.
 Specify a source bit map file.
 Marking the [Copy to the library folder for use] check box copies the source file to the library folder before use. Specify the bit map file name to be added in the [File name] box.
 Enter a bit map name to be added.
 Confirm the above specifications and click on [Add].

[Save bitmap]

Displays a class for the adding.

A list of members of the selected class appears.

Specify a source bit map file.

Marking this check box copies the source file to the library folder before use.

Specify a bit map name to be added.

Specify a bit map file name to be added.

Marking this check box allows icons to be larger.

Marking this check box displays only names in the member list.

(9) Maintenance (M)

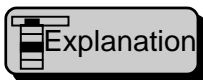

Explanation

This menu is used to rearrange library file configurations, such as adding a class to a library, deleting a class or member from the library.

1. Parts (P)

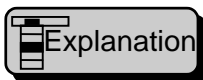

Explanation

This function changes, adds, and deletes the icon and comment of a class for a component library as well as changes and deletes the name of a library component.

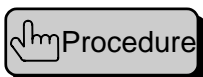

Procedure

The [Maintenance of parts] dialog box appears.

Maintain the component library.

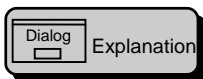

Dialog Explanation

[Maintenance of parts]

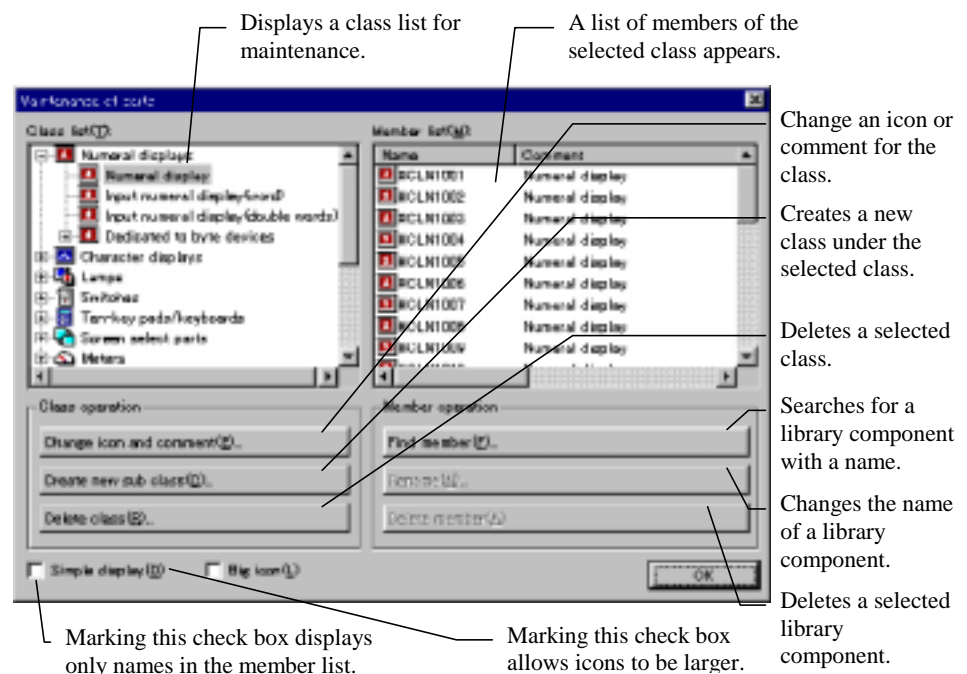

◇ Change icon and comment.

The [Icon and comment of the selected class] dialog box appears. Then specify an icon and comment before clicking on [Run].

◇ Create new sub class.

The [Icon and comment of the new class] dialog box appears. Then specify an icon and comment before clicking on [Run].

◇ Delete class.

The [Delete class] dialog box appears. Verify contents of the class and click on [Run] when you want to delete it. When the class contains members, a confirmation message appears, which tells that members are also deleted.

◇ Find member.

The [Find member] dialog box appears. You may use this function for searching a class to which the library member for maintenance belongs. Enter its name and click on [Run].

- ◇ Rename.
The [Rename] dialog box appears. Enter a new component name and click on [Run] when you want to change a library member name.
- ◇ Delete member
Deletes a selected member. A confirming message appears. Then click on [OK] when you want to delete it.
- ◇ Ok
Ends the maintenance.

 Explanation
[Icon and comment of the selected class]

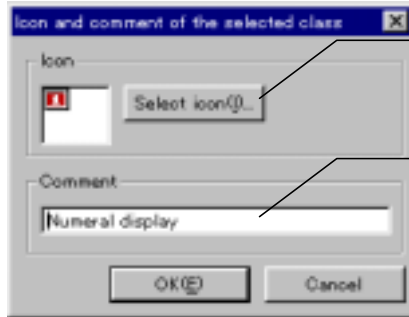

Set an icon
Enter a comment.

 Explanation
[Icon and comment of the new class]

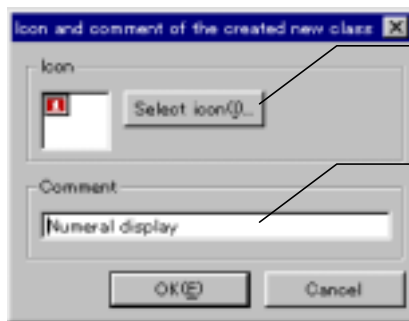

Set an icon
Enter a comment.

 Explanation
[Delete class]

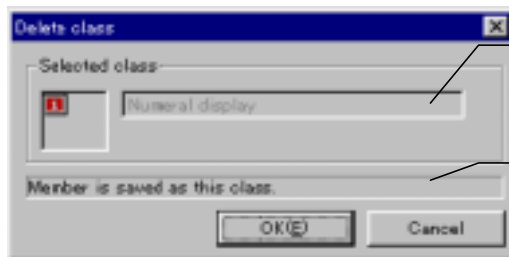

Displays an icon and comment for the selected class
A message appears if some members belong to the class.

 Explanation
[Find member]



Enter a name to be searched for.

 Explanation
[Rename]

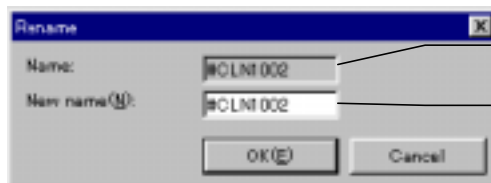

Displays the current name.
Enter a new name.

2. Texture (T)

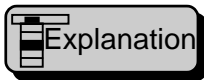

Explanation

This function changes, adds, and deletes the icon and comment of a class for a texture library as well as changes and deletes the name of a library texture.

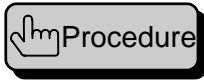

Procedure

The [Maintenance of texture] dialog box appears.
Maintain the texture library.

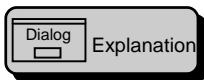

[Maintenance of texture]

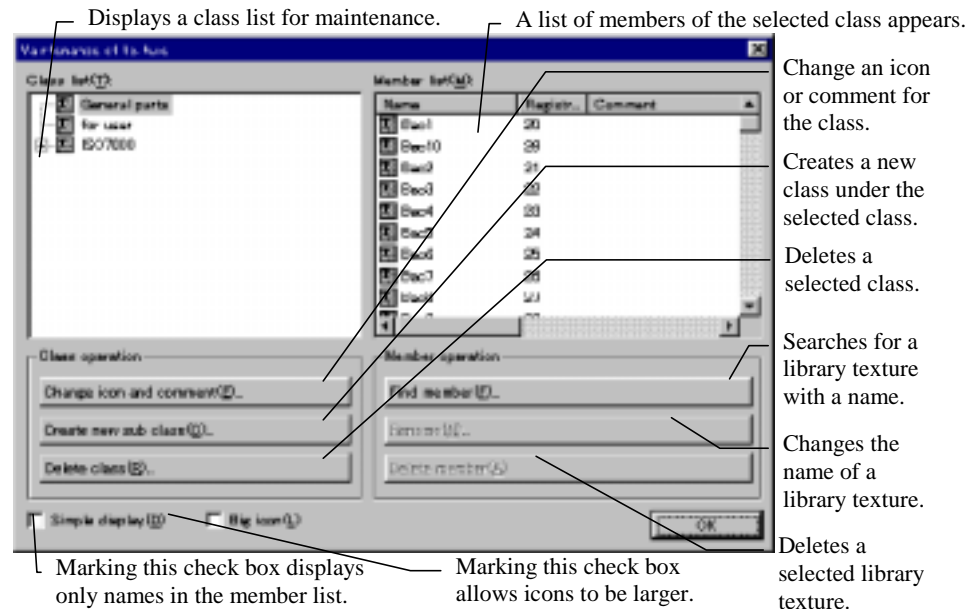

◇ Change icon and comment.

The [Icon and comment of the selected class] dialog box appears. Then specify an icon and comment before clicking on [Run].

◇ Create new sub class.

The [Icon and comment of the new class] dialog box appears. Then specify an icon and comment before clicking on [Run].

◇ Delete a class.

The [Delete class] dialog box appears. Verify contents of the class and click on [Run] when you want to delete it. When the class contains members, a confirmation message appears, which tells that members are also deleted.

◇ Find member.

The [Find member] dialog box appears. You may use this function for searching a class to which the library member for maintenance belongs. Enter its name and click on [Run].

◇ Rename.

The [Rename] dialog box appears. Enter a new texture name and click on [Run] when you want to change a library member name.

◇ Delete member.

Deletes a selected member. A confirming message appears. Then click on [OK] when you want to delete it.

◇ Ok

Ends the maintenance.



For more information on the procedure and dialog, refer to Section 4-5 (9) 1. Component.

3. Bitmap (B)

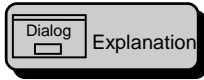
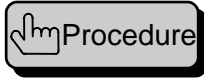
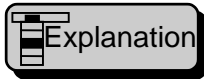

Explanation
[Maintenance of bitmap]

This function changes, adds, and deletes the icon and comment of a class for a bit map library as well as changes and deletes the name of a library bit map.

The [Maintenance of bitmap] dialog box appears.
Maintain the bit map library.

Displays a class list for maintenance.

A list of members of the selected class appears.

Change an icon or comment for the class.

Creates a new class under the selected class.

Deletes a selected class.

Searches for a library bit map with a name.

Changes the name of a library bit map.

Deletes a selected library bit map.

Marking this check box displays only names in the member list.

Marking this check box allows icons to be larger.

- ◇ **Change icon and comment.**
The [Icon and comment of the selected class] dialog box appears. Then specify an icon and comment before clicking on [Run].
- ◇ **Create new sub class.**
The [Icon and comment of the new class] dialog box appears. Then specify an icon and comment before clicking on [Run].
- ◇ **Delete class.**
The [Delete class] dialog box appears. Verify contents of the class and click on [Run] when you want to delete it. When the class contains members, a confirmation message appears, which tells that members are also deleted.
- ◇ **Find member.**
The [Find member] dialog box appears. You may use this function for searching a class to which the library member for maintenance belongs. Enter its name and click on [Run].
- ◇ **Rename.**
The [Rename] dialog box appears. Enter a new bit map name and click on [Run] when you want to change a library member name.
- ◇ **Delete member**
Deletes a selected member. A confirming message appears. Then click on [OK] when you want to delete it.
- ◇ **Ok**
Ends the maintenance.



For more information on the procedure and dialog, refer to Section 4-5 (9) 1. Component.

4-6 Tool (T)

(1) Display (V)

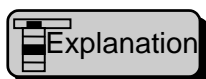

Explanation

This function specifies mainframe layout (presence/absence of a tool bar), a displaying method of a child window, etc.

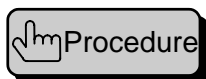

Procedure

Select a menu and opens the [Display] dialog box.
Specify parameters.

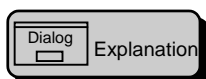

[Display]

Explanation

End this procedure, clicking on [Exit]. If you want to open this dialog box with the specified parameters in this dialog box, click on the [Default next time] button. Then the parameters including the child window are used every time the system starts up.

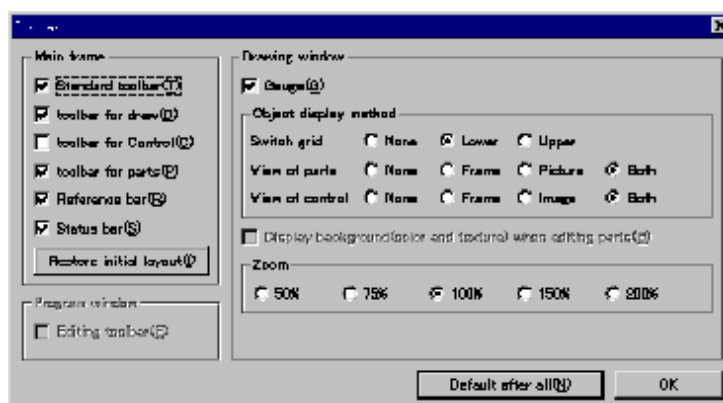

- ◇ Main frame/Standard toolbar (T)
Marking this check box allows the standard tool bar to appear.
- ◇ Main frame/Toolbar for draw (D)
Marking this check box allows the drawing tool bar to appear.
- ◇ Main frame/Toolbar for control (C)
Marking this check box allows the control tool bar to appear.
- ◇ Main frame/Toolbar for parts (P)
Marking this check box allows the component tool bar to appear.
- ◇ Main frame/Reference bar (R)
Marking this check box allows the reference tool bar to appear.
- ◇ Main frame/Restore initial layout (S)
Marking this check box allows the status tool bar to appear.
- ◇ Main frame/Return to initial state tool bar (I)
Returns the mainframe tool bar status to the one immediately after the installation.
- ◇ Drawing window/Gauge (G)
Marking this check box allows a bar (gauge) with scales to appear on the left and at the top of the drawing window.

- ◇ Drawing window/Object display method/Switch grid
Specifies displaying method for the switch grid as follows.
None: No display.
Back: Displays the switch grid on the background of a figure or component.
Fore: Displays the switch grid on the foreground of a figure or component.
- ◇ Drawing window/ Object display method /View of parts
Specifies displaying method for a component arranged on the screen as follows.
None: No display.
Frame: Displays a frame only.
Figure: Displays a figure only.
Both: Displays a frame and figure.

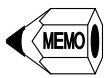

- A frame is conveniently used for confirming the area and for editing. When you are in editing, click on a frame you want to select. Usually, the frame is being displayed.

- ◇ Drawing window/ Object display method /View of control
Specifies displaying method for a control attached to a component as follows.
None: No display.
Frame: Displays a frame only.
Image: Displays an image only.
Both: Displays a frame and image.

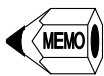

- A frame is conveniently used for confirming the area and for editing. When you are in editing, click on a frame you want to select. Usually, the frame is being displayed.
- The image display is used to display an outline of the image on the panel. It is recommended that the image outline be displayed while you are editing.

- ◇ Drawing window/Display background(color and texture)when editing parts (B)
Marking this check box allows the background color and texture specified as component's properties to be displayed in editing a component.

- ◇ Drawing window/Zoo
Select a ratio of scale-up or scale-down of the window.



- When scale-up or scale-down is specified, thickness of a line or filling a figure may not be correct. Usually, specify 100 %.

- ◇ Program window/Editing toolbar (E)
Marking this check box combines the tool bar to the program-editing window for display. (You cannot use this function for floating.)

(2) Option (O)

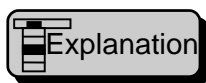

Explanation

This function sets default parameters when you use a tool.

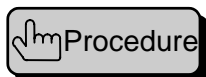

Procedure

Select a menu and opens a dialog.

Specify parameters.

Click on the [Exit] button.

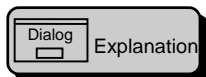

Dialog Explanation

[Option]

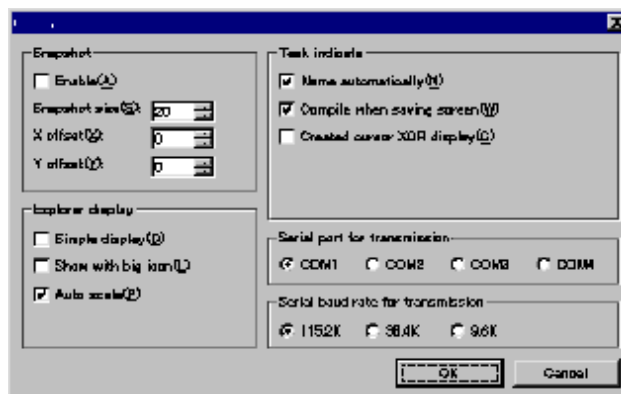

◇ Snapshot/enable (A)

Marking this check box makes the snap effective. (This function is to limit dots on a grid, which you can specify with a mouse.) You can specify this parameter with the standard tool bar.

◇ Snapshot/Snapshot size (S)

Enter a grid size for snap within 1 to 100 dots.

◇ Snapshot/X offset (X)

Enter an X value for offset, using the base grid (0, 0). The value must be from 1 to 19 dots.

◇ Snapshot/Y offset (Y)

Enter a Y value for offset, using the base grid (0, 0). The value must be from 1 to 19 dots.

◇ Explorer display/Simple display (D)

When this check box is marked, you can use Explorer (selection objective dialog: Open a screen, preview, etc.) to change the list display from the compound type to the simple type. In the compound type, a lot of information can be displayed even with sort, but one line contains only one item. On the other hand, in the simple type, the information is only name, so that you can browse more items.

You can set this parameter through a dialog.

- ◇ Explorer display/Show width big icon (L)
Marking this check box allows larger icons to be displayed.
You can set this parameter through a dialog.
- ◇ Explorer display/auto scale (P)
When this check box is marked, a display image is fitted into the preview frame in automatic scale in displaying with the preview (a button or list having the check function of an image before open). If you do not use this automatic scale function, a part of a larger pattern may hang out of the view frame.
You can set this parameter through a dialog.
- ◇ Task indicate /Name automatically (N)
Marking this check box allows a component or control to be given a name automatically. Thus you can omit the name entry.
- ◇ Task indicate/Compile when saving screen (W)
Marking this check box allows a program to be compiled at saving the screen. With this parameter, you can check whether or not errors exist in the program you have just written or edited. You are recommended to mark this check box. However, you may compile together with other screens later; when generating downloading programs.
- ◇ Task indicate/Created cursor XOR display (C)
When this check box is marked, the cursor to be displayed at creating a drawing element is changed from the overlapping cursor to the XOR cursor. When adjusting a position with another figure, you can use the XOR cursor conveniently.
- ◇ Serial port for transmission
Specify a number of the serial port (RS232C) to be used for uploading or downloading.
You can set this parameter through a dialog.
- ◇ Serial baud rate for the transmission
Specify a transfer rate of the serial port to be used for uploading or downloading. In general, the default value is used, but you may change it if an error is detected.
You can set this parameter through a dialog.

(3) List browse (B)

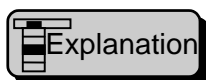

Explanation

The list in this dialog displays current data in a list form when a screen or component is edited in a window. With this list, you can specify selection status for editing.



Procedure

Open the dialog, selecting a menu or clicking on a standard tool bar button. When you want to change selection status, click on a list item to display it in the reverse image. To select two or more items, list-click with [Ctrl] pressed. When the [Selection] button is pressed, the list selection status is reflected to the window and a handle is attached to the data. When a component is selected in the list and the [attribute or property] button is pressed, the dialog is closed and the change attribute dialog is opened. When a component is selected in the list and the [Edit contents of parts] button is pressed, the dialog is closed and the editing a component window is opened.

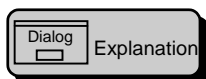

Explanation

[list browse]

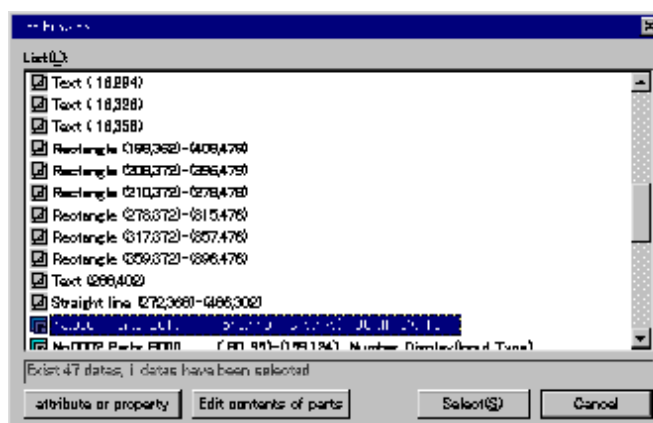

◇ List (L)

This function displays all data created up to now in the displaying order. Data selected on the screen appear in the reverse image (default).

- This function is incorporated in the standard tool bar with a button.



(4) View (L)

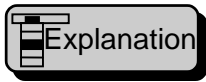

This function is intended to confirm final display with indicating a figure close to a real image, excluding switch grids and component frames. This is also convenient for confirming a panel having a different number of colors.

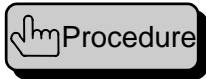

Select a menu and open a dialog box.
Click on the [Exit] button when confirming the image.

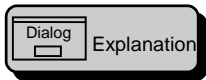

[Display Confirmation]

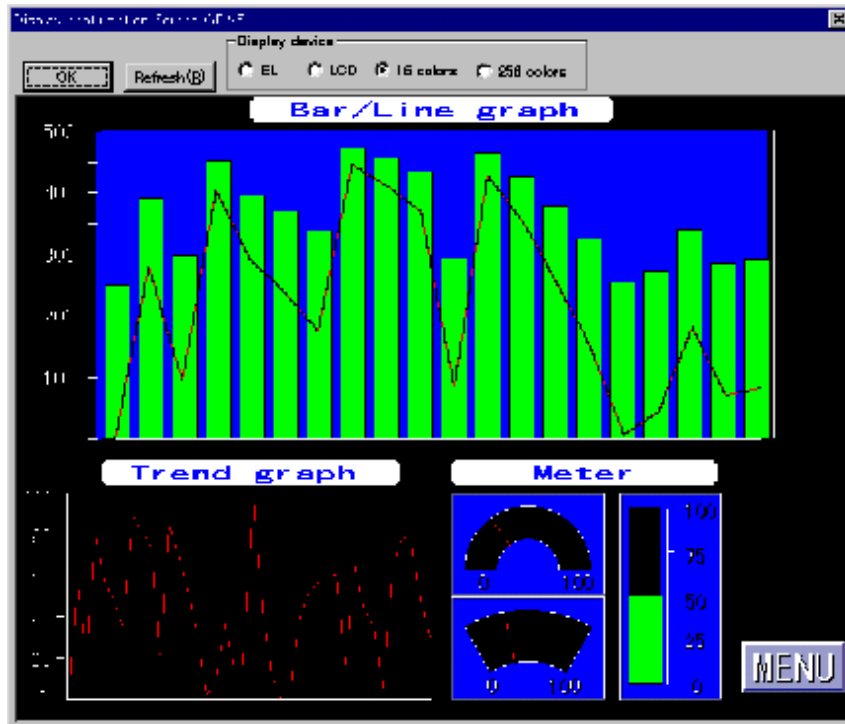

- ◇ Ok
Ends and closes the dialog.
- ◇ Refresh (R)
Redisplays the image.
- ◇ Display device
Switches a display device on the panel.

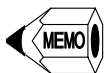

- Every time the redisplay button is clicked, display of the control with blinking specified changes in status.



- The real font is different form that on the panel.

(5) Restore previous system (R)

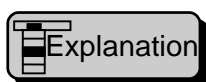

Explanation

This function is designed for copying data created in the 3000 series (GC-SGP3) into this tool, so that you can edit the data. This operation is equivalent to create a new project. It is very important to back up the conventional data with GC-SGP3 before restoring it. Once the data is restored, it is not needed anymore.

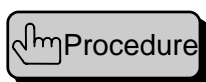

Procedure

Select a menu and open a dialog box.

Enter a system file of the backed up system.

Select a panel on which a new project is to be created.

If the panel becomes larger, specify the position where the screen is cut off.

Click on the [Run] button and the restoring operation begins. The progress of the operation is displayed with a message.

When the resultant message appears, click on the [Exit] button.

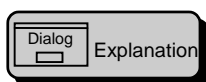

Dialog Explanation

[Restore previous system]

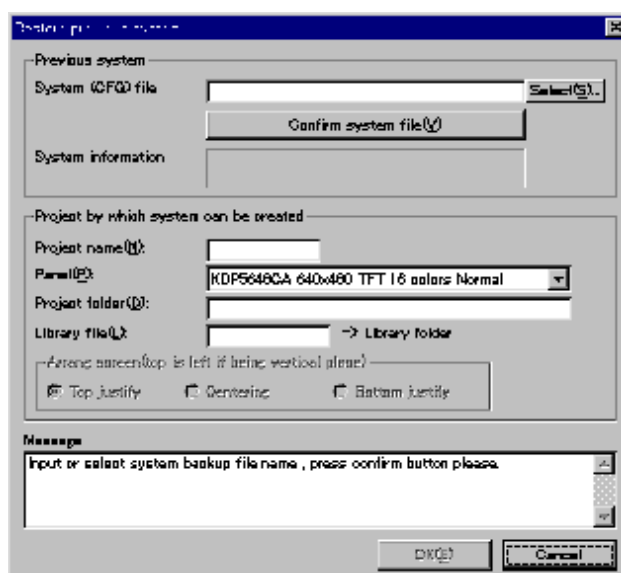

- ◇ Previous system/System (CFG) file
Enter a system file name (system-name.CFG) for the backed up system.
- ◇ Previous system /Select (S)
Open the selection dialog for choosing a file name directly from the list.
- ◇ Previous system /Confirm system file(V)
When entering a system file, click on this button. Then the system file is loaded and information necessary for creating a new project is searched for.
- ◇ Previous system /System information
The system information appears, which is loaded when the system file confirmation button is clicked.
- ◇ Project by which system can be created/Project name (N)
Enter a name of a new project. The default name is the system name.
- ◇ Project by which system can be created /Panel (P)
Select a panel type for a new project. The default is the panel closest to the one specified by the system.

- ◇ Project by which system can be created /Project folder (D)
Enter a name of a new project folder. In general, you need not enter it since a default value is used. If there is no folder, it is automatically created.
- ◇ Project by which system can be created /Library file(L)
Enter a name of a new library file. In general, you need not enter it since a default value is used. If there is no folder, it is automatically created.
- ◇ Project by which system can be created /Arrange screen(top is left if being vertical place)
Specify the method to fit the two screens. This function becomes effective only when the sizes of the system screen and new project panel are different.
- ◇ Message
A message in progress or result appears.



- A library (stored figures and bit maps) in the conventional system is converted into a new library (texture and Windows bit maps) and saved. If the same name exists in the new library, you can specify that the library is to be overridden.



- The result is displayed in the reverse image.
- Make sure to create downloading date before GC-SGP3 makes system backup. Data for which the downloading has not yet been made cannot be restored correctly.
- A library (stored figures and bit maps) in the conventional system is converted into a new library (texture and Windows bit maps) and saved. If the same name exists in the new library, you can specify that the library is to be overridden. If the existing one is overridden, the display with the current project may change. If you do not override it, the display for restoring data may change. Thus you are requested to choose either way, considering which is more risky.



For more information on 3000 series data backup, refer to Section 11.3 (2), Backup in GC-SGP3 Operation Manual (Details).

(6) Numeric input browse (N)

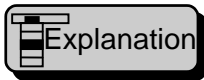

Explanation

Selecting this menu causes the ten-key dialog to be open, where you can enter numeric values for inserting them in a program. This menu becomes effective only when a program is edited in the window.

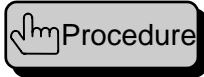

Procedure

Select the numeric input browse on the menu or tool bar to open a dialog box. Enter a numeric value and click on the [OK] button. The dialog is closed and the entered value is inserted into a program.

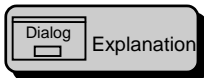

Dialog Explanation

[Ten-key]



The functions of the ten-key are almost the same as those of an electric calculator, with which you can perform arithmetic operations and hexadecimal conversion. Numeric values converted into hexadecimal values are inserted into a program and used in the hexadecimal notation.

4-7 Window (W)

(1) Cascade (C)



Explanation

This function piles up screen for display.

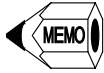

- The selected window comes in the front.

(2) Vertical tile (H)

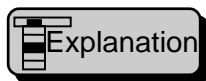

Explanation

This function lays out screens vertically. When four or more screens exist, they are tiled.



- The selected window comes at the left upper position.

(3) Horizontal tile (T)

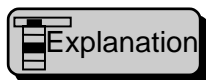

Explanation

This function lays out screens horizontally. When four or more screens exist, they are tiled.

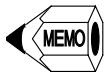

- The selected window comes at the left upper position.

(4) Arrange to object size (O)

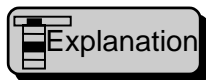

Explanation

This function changes the window size to agree with the component or screen size being edited.



- This function is ineffective for a program window.

(5) Arrange icon (A)

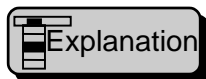

Explanation

This function aligns minimized windows (icons).

4-8 Project (P)

(1) New (N)

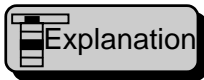

Explanation

This function is to create a new project.

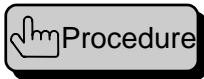

Procedure

Select a menu and open a dialog box.

Enter properties (definitions and setup parameters). The minimum requests are a project name and panel type. The other properties are automatically set.

A confirmation message for creating a folder appears. Usually, click on [OK].

Change a page and enter connected units.

Click on [OK] to end the dialog.

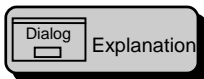

Explanation

[Create new
property of
Project]

- Definition for one project per page.

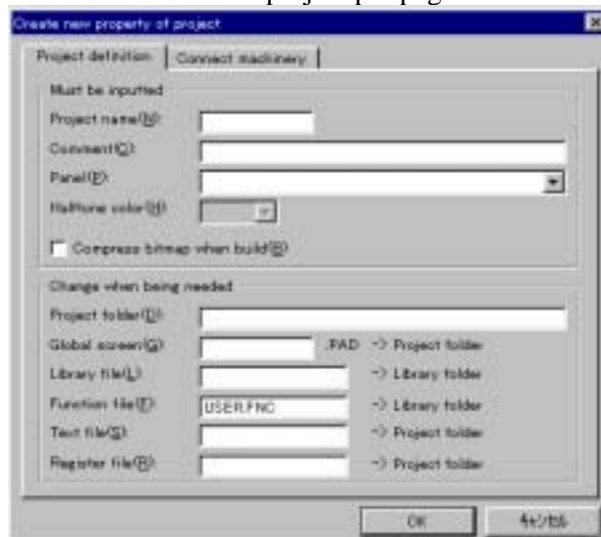

- ◇ Project name (N)

Enter a project name with up to eight alphanumeric.

- ◇ Comment (C)

Enter a comment, which is optional. The comment entered here will be displayed when the project is opened. You are recommended to enter a brief explanation as the comment for selection convenience of the project.

- ◇ Panel (P)

Select the type of a panel where created data is downloaded. For the selection, pull down the combo-box and click on an item on the list.

- ◇ Halftone color (H)

Specify a color when half tone (shade) is designated as component status. For the selection, pull down the combo-box and click on an item on the list. This parameter is made effective when a panel is selected.



- ◇ Compress bitmap when build (B)
Marking this check box causes a bit map to be compressed at creating downloading data. It is noted that the compression saves memory space but displaying time becomes longer slightly.
- ◇ Project folder (D)
Specify a folder which accommodate a screen created by the project as a file. The default folder is automatically created.
- ◇ Global screen (G)
Specify a global screen name to be used by the project. The default folder is automatically created.
- ◇ Library file (L)
Specify a component library name to be used by the project. The default folder is automatically created.
- ◇ Function file (F)
Specify the name of a file accommodating a user function to be used by the project. The default folder is automatically created.
- ◇ Text file (S)
Specify the name of a file character strings to be used by the project. The default folder is automatically created.
- ◇ Record file (R)
Specify the name of a file accommodating project information. The default folder is automatically created.
- Page 2, connected units

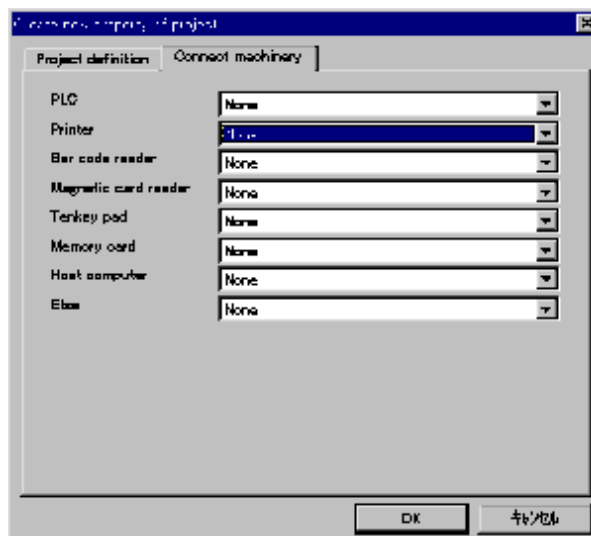

- ◇ PLC, printer, bar-code reader, and so forth
A list of connected units appears. In the default state, no unit is connected. For the connection, pull down the comb-box and click on an item on the list.
- After new creation, close the currently opened project, when existing. Then the project is switched to the new one.
- If no project folder exists (default), a confirmation message asking whether or not you want to create a folder appears. Usually, click on [OK] for the creation.
- Seeing the message [Change it as needed], you are not recommended to change.



If you change it carelessly, the following operations are not very convenient. Use it as it is (default value).

- Make sure to create a project folder (a confirmation message appears), or specify an existing one.

(2) Open (O)

This function opens a project. It is used to open a project which is not yet open or to switch it to another project.

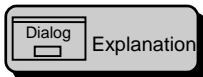
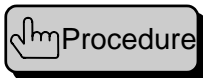
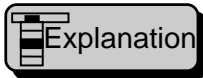

[Open project]

Select a menu and open a dialog.

When a list of existing objects appears, then select an object you want to open. To select an object, click on the name to make it in the reverse image and click on the [OK] button. Or double-click on the name.

When the name is selected, the dialog is closed and the project is open.

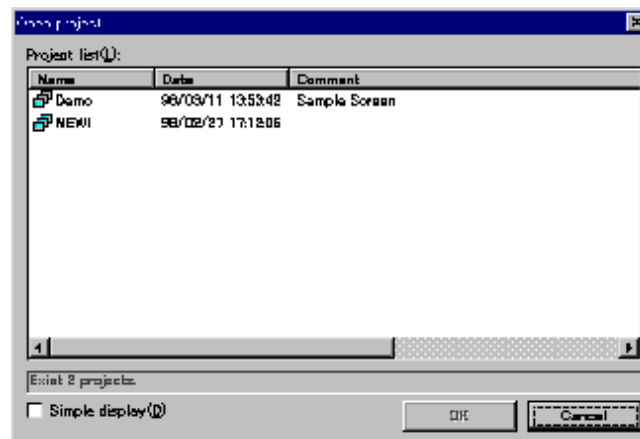

◇ Project list (L)

Displays a list of existing projects.

◇ Simple display (D)

Marking this check box causes a list of only project names to appear. Thus more project names can be displayed.

- When you execute this function, a currently opened project is automatically closed.



- You cannot create or edit a screen unless the project is open.



(3) Close (C)



This function closes a project. When closing a project, you cannot create or edit a screen. Usually, you need not close a project.

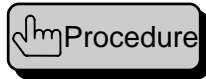

Select a menu.

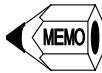

- When a project is closed, properties of the current project and library information are saved to a project file.

(4) Property of project (P)

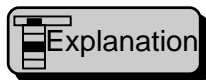

This function enters or changes project properties (definitions and parameters). In general, it is used to check properties.

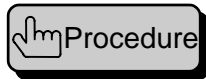

Select a menu and open a dialog box.
Enter or change properties on an as needed basis.
Click on [OK] to end the function.

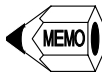

- You cannot enter or change a name.



- The portion of [Change it as needed] becomes effective when the project is closed.



The dialog is the same as that opened in the new creation section. Refer to each item in the creation section.

(5) Print project (L)

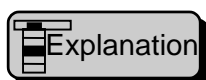

This function archives such information as screens and character strings created by the project as a document in a form of document. The document is stored in a Windows standard file, so that you can use it later.



Select a menu and open a dialog box.
Check items that you want to archive as documents.
Select screens for documentation. You can select a screen when clicking on a name on the screen list. When a screen has already been selected for addition or the selection is to be released, click on it with the Ctrl key pressed. The default setting is that recorded screens are selected.
Click on the [Run] button to start documentation.

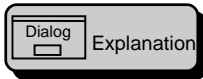

[Print project]

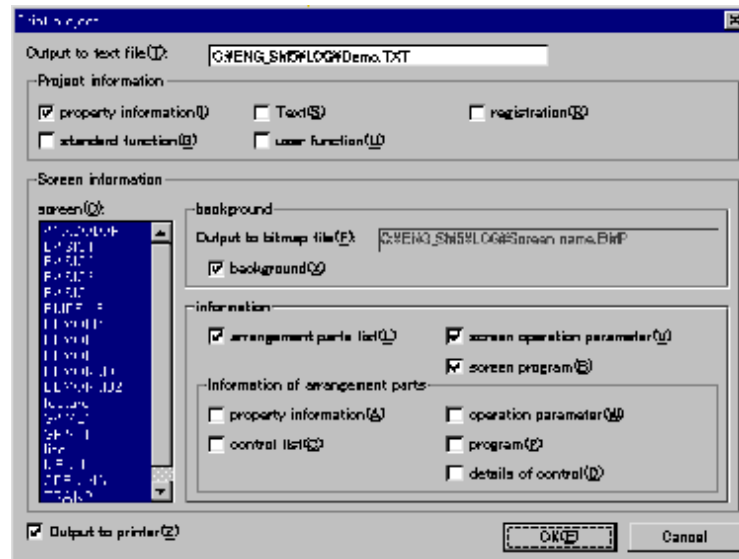

- ◇ **Output to text file (T)**
Enter a path for a file name accommodating a document in text. You need not specify it since a default path is set.
- ◇ **Project information/property information (I)**
Marking this check box causes project properties (name, comment, panel type, etc.) to be written in text (documentation).
- ◇ **Project information/Text (S)**
Marking this check box causes character strings to be written in text (documentation).
- ◇ **Project information/Registration (R)**
Marking this check box causes a list of records (screens and character strings) to be written in text (documentation).
- ◇ **Project information/Standard function (G)**
Marking this check box causes standard functions to be written in text (documentation).
- ◇ **Project information/User function (U)**
Marking this check box causes functions created at drawing project screens and at writing component programs to be written in text (documentation).
- ◇ **Screen information/Screen (O)**
Select screens to be archived as documents. You may select more than one screen and the selected screens are displayed in the reverse image.
- ◇ **Screen information/Background/Output to bitmap file (F)**
- ◇ **Screen information/Background/Background (X)**
When the Store background check box is marked, the screen pattern is written in a bit map file with the same screen pattern at opening Windows. The bit map file name is "Log-folder-screen-name.BMP".
- ◇ **Screen information/Information/Arrangement parts list (L)**
Marking this check box causes a list of components arranged on a screen to be written in text (documentation).
- ◇ **Screen information/Information/Screen operation parameter (V)**
Marking this check box causes screen action parameters to be written in text (documentation).
- ◇ **Screen information/Information/Screen program (B)**

- Marking this check box causes a screen program to be written in text (documentation).
- ◇ Screen information/Information/Information of arrangement parts/property information (A)
Marking this check box causes properties of components arranged on a screen to be written in text (documentation).
 - ◇ Screen information/Information/Information of arrangement parts /Operation parameter (W)
Marking this check box causes action parameters of components arranged on a screen to be written in text (documentation).
 - ◇ Screen information/Information/Information of arrangement parts/Control list (C)
Marking this check box causes a control list of components arranged on a screen to be written in text (documentation).
 - ◇ Screen information/Information/Information of arrangement parts/Program (P)
Marking this check box causes a program of components arranged on a screen to be written in text (documentation).
 - ◇ Screen information/Information/Information of arrangement parts/Details of control (D)
Marking this check box causes detail parameters of controls contained in components arranged on a screen to be written in text (documentation).
 - ◇ Output printer (Z)
Marking this check box causes to write information onto a document file and print it.

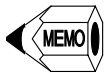

- You can edit the resultant text file (.TXT) by using Memo Pad or Word Pad.
- You can edit the resultant bit map file (.BMP) by using Paint.



- Screen Creator 5 does not delete the output files (.TXT and .BMP). Delete them on Windows when you do not want them anymore.

(6) Register (R)

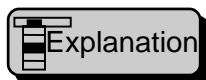

This function records a screen, character strings, and textures to be downloaded. All screens to be downloaded must be recorded. Especially, you must note that screen 1 is mandatory for the first screen at the time of OIP activation. You also note that the global screens must not be recorded.

Record a character string or texture if you want to display with its number in an action parameter or program. You need not to record a texture or component background pasted on a screen.

You may record screens and textures up to 1023 and 1024, respectively.

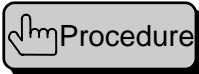

Select a menu and start a dialog.

Click on a name for a recording number to display in the reverse image. When click on it again, carets (^^^) appear in the reversed image position, where enter a name. When clicking on the [Reference] button, a selection dialog opens, where you can select a name.

Click on the [Exit] button.

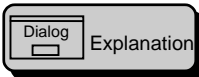

Explanation

[Register to project]

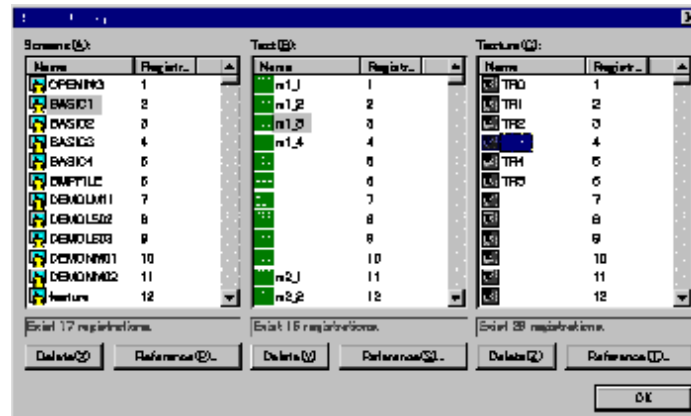

◇ Screens (A)

◇ Text (B)

◇ Texture (C)

A list of respective recording items appears.

◇ Delete (X)

◇ Delete (Y)

◇ Delete (Z)

Deletes an item in the reverse image, which makes non-recording state.

◇ Reference (P)

◇ Reference (S)

◇ Reference (T)

Opens a selection dialog of respective item.

- When you have entered a recording item with the [Reference] button pressed, another selection dialog appears consecutively. To end the recording, click on the Cancel button in the dialog.



- Do not record a global screen.

- Be sure to record screen 1, which is the first screen at the time of power up.

- You cannot record one screen with two numbers.

- You may record one character string or texture with two numbers.



(7) Download (D)

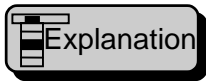

This function generates data to be transferred to the panel from screens and character strings created with a project. Then it sends the data to the panel.

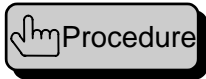

Select a menu and activate a dialog.
 Connect the panel to a computer, make the panel in downloading state, and press the [Build -> Transmit] button.
 Should an error occur during data generation, close the dialog and check its cause.
 Once the transfer begins, the operation is relayed to the [Upload/Download] window and this dialog is closed automatically. To end the dialog, click on the [Break] or [End] button.
 The [Upload/Down load] operation starts automatically. When the transfer ends, click on the [End] button to close the dialog.



If screen 1 does not contain any item, an error occurs before the dialog opens.

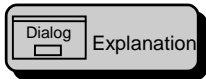

[Down load]

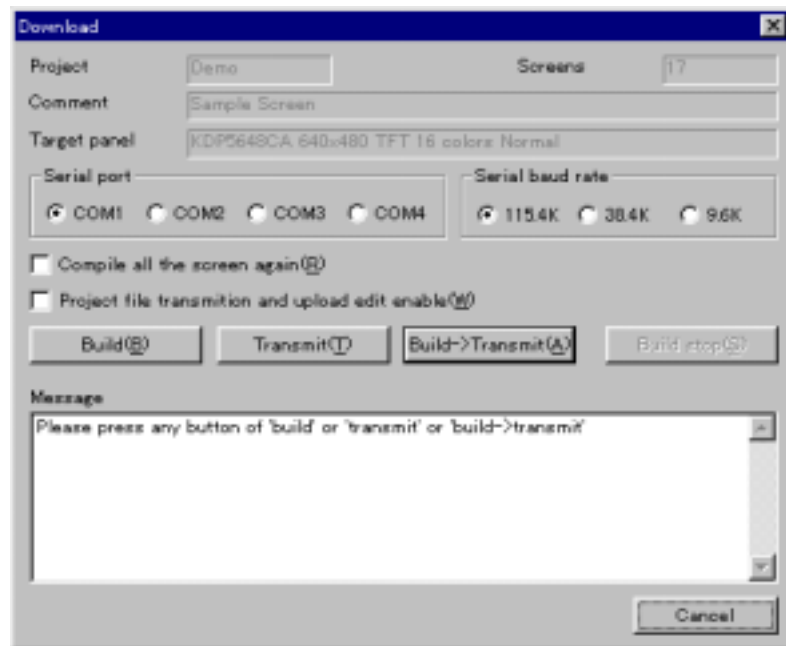

- ◇ Project
- ◇ Screens
- ◇ Comment
- ◇ Target panel
 Displays information of the currently opened project. The panel to be connected must be presented here.
- ◇ Serial port
 Select the number of a serial port to be connected.
- ◇ Serial baud rate
 Select a transfer rate of the serial port to be connected.
- ◇ Compile all the screen again (R)

Marking this check box causes all screens to be recompiled without date comparison (skipping recompilation).

◇ Project file transmission and upload edit file enable (W)

Marking this check box causes all files used in the project to be added to downloading data and then the resultant data to be downloaded to the panel. You can use this downloaded data to restore and edit the project when uploading it.

◇ Build(B), Transmit(T), Build ->Transmit(A)

Clicking the button causes individual operation.

◇ Build stop(S)

Clicking on this button cancels the generation.

◇ Message

A message in progress or result appears.

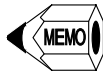

- When you want to confirm correctness of data, click on the [Build] button. This operation does not cause data to be sent to the panel, but to be generated.
- When the generation has been complete successfully, simply click on the [Transmit] button. This operation causes only sending.
- The result of the generation is displayed in the reverse image.



- The upper limit of communication speed (RS232C) depends on how fast your computer is. The maximum transfer rate of Screen Creator 5 is 115.2 KB/sec. If your computer does not support the speed, lower the transfer rate.



- When "Send also a project file and make upload file effective" is selected, the size of downloaded data is larger than that of the added data to the file. If a project file is added to data occupying a large part of the panel user memory, the size of downloading data may exceeds that of the panel memory. This blocks the downloading operation.



- Since the project file is added to downloading data, the file is compressed so as to reduce the file size. This compression is performed with UNLHA.DLL free ware (Author: Mr. Micco). Therefore, the LHA mouse pointer appears while the file is being frozen.

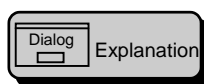

[Upload/Down-load]

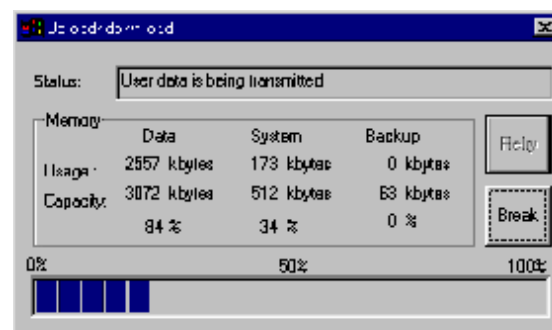

◇ Status

Displays progressing status of downloading. If an error occurs, its contents are displayed.

◇ Memory

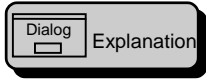

[Upload]

- ◇ Displays used amount of data memory, system memory, and backup memory. It also displays the OIP capacity and its use rate.
- ◇ Progress bar
This bar graph displays the current rate of data transfer.
- ◇ Retry
This button is for re-transferring data.
- ◇ End
This button is for termination of data transfer and closing the window.

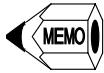

- The Upload/Down load is not a dialog but a window. Accordingly, you can use Screen Creator 5 during downloading. Note that two or more Upload/Down load cannot be started.



- If a communication error occurs during downloading, you have possibly set a communication speed higher than that your computer supports. Check the upper limit of the communication speed of your computer and set Screen Creator 5 whose maximum speed must be lower than that of your computer.

(8) Upload (U)

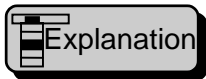

This function picks up data downloaded on a panel, which can be downloaded to another panel. If a project file is added to the picked up data, the project can be restored.

1. Upload (U)

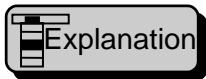

This function picks up data downloaded on a panel, which is downloaded to another panel or used to restore a project file.



Select a menu and open a dialog.

Connect the panel to a computer, make the panel in downloading state, and press the [Ok] button. The [Upload/Down load] windows is open and it takes up this transfer operation. Then the dialog box is closed.

The [Upload/Down load] starts transfer automatically. When the transfer ends, click on the [Cancel] button to close the window.



- ◇ Project
Project name is fixed to "Untitled".
 - ◇ Panel/Size of horizontal display (X)
Select an indicator resolution for the connected panel indicator in the longitudinal direction.
 - ◇ Panel/Size of vertical display (Y)
Select an indicator resolution for the connected panel indicator in the latitudinal direction.
 - ◇ Panel/Panel type
Select the type of an indicator in the panel connected to your computer.
 - ◇ Serial port
Select the number of a serial port to be connected.
 - ◇ Serial baud rate
Select a transfer rate of the serial port to be connected.
 - ◇ Transmission
The file name is fixed to NONAME.AP5 in the PA_UPX folder. You cannot change the name.
- Uploading overwrite the NONAME.AP5 file in the PA_UPX folder. If you want to keep the uploaded file, copy NONAME.AP5 to another file, using a Windows function (such as Explorer). If you want to perform the reverse operation, copy the preserved one (copied NONAME.AP5) to the PA_UPX folder and execute [Download uploading project].
 - You can upload data to which a project file has not been attached. However, it cannot be used for restoring the project and editing.
 - The upper limit of communication speed (RS232C) depends on how fast your computer is. The maximum transfer rate of Screen Creator 5 is 115.2 KB/sec. If your computer does not support the speed, lower the transfer rate.



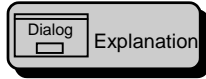

[Upload/Download]

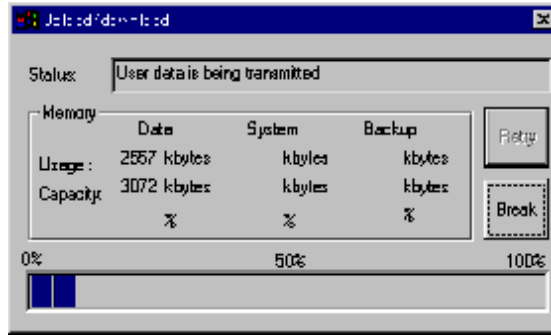

- ◇ **Status**
Displays progressing status of uploading. If an error occurs, its contents are displayed.
- ◇ **Memory**
Displays used amount of data memory as well as the OIP capacity and its use rate.
- ◇ **Progress bar**
This bar graph displays the current rate of data transfer.
- ◇ **Retry**
This button is for re-transferring data.
- ◇ **End**
This button is for termination of data transfer and closing the window.

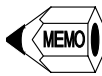

- The Upload/Down load is not a dialog but a window. Accordingly, you can use Screen Creator 5 during uploading. Note that two or more Upload/Download cannot be started.



- If a communication error occurs during uploading, you have possibly set a communication speed higher than that your computer supports. Check the upper limit of the communication speed of your computer and set Screen Creator 5 whose maximum speed must be lower than that of your computer.

2. Restore Uploading Project (R)

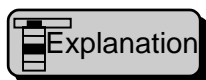

When a project file is attached to uploaded data, the project is restored.

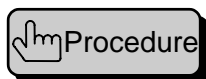

Select a menu and open a dialog. In this case, the mouse pointer shape changes to the LHA form in order to melt the project file. Clicking on the Run button causes restring operation to start and progressing messages to appear. Viewing the result message, click on the Exit button.

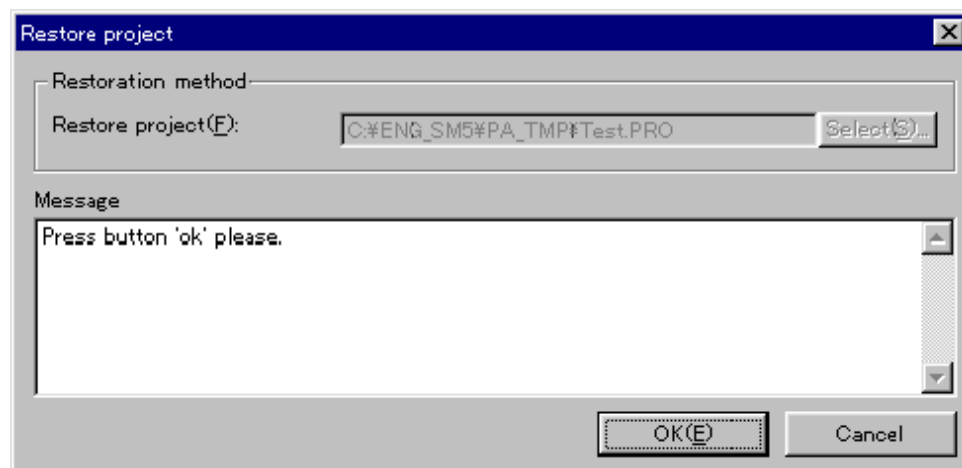

- ◇ Restoration method/Restore project (F)
The project name is fixed to the one when the downloading data is generated.
You cannot change it.
- ◇ Message
Progressing status and result appear.



- The result of the restore is displayed in the reverse video.



- When a backed up screen or library is restored, it replaces the existing one. This operation causes the resultant screen or library to be given an old date. Thus, specify [Re-compile all screen] function for the downloading data preparation.



- Since the project file is added to downloading data, the file is compressed (frozen) so as to reduce the file size. To restore the project, the frozen data must be melted. This melting operation is performed with UNLHA.DLL free ware (Author: Mr. Micco). Therefore, the LHA mouse pointer appears while the file is being melted.

3. Download Uploading Project (D)

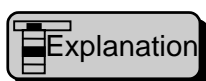

This function down loads data uploaded from the panel.

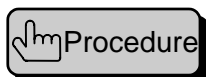

Select a menu and open a dialog.

Connect the panel to a computer, make the panel in downloading state, and press the [OK] button. The [Upload/Download] windows is open and it takes up this transfer operation. Then the dialog box is closed.

The [Upload/Download] starts transfer automatically. When the transfer ends, click on the [End] button to close the window.

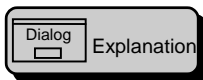

[Download the uploaded project]

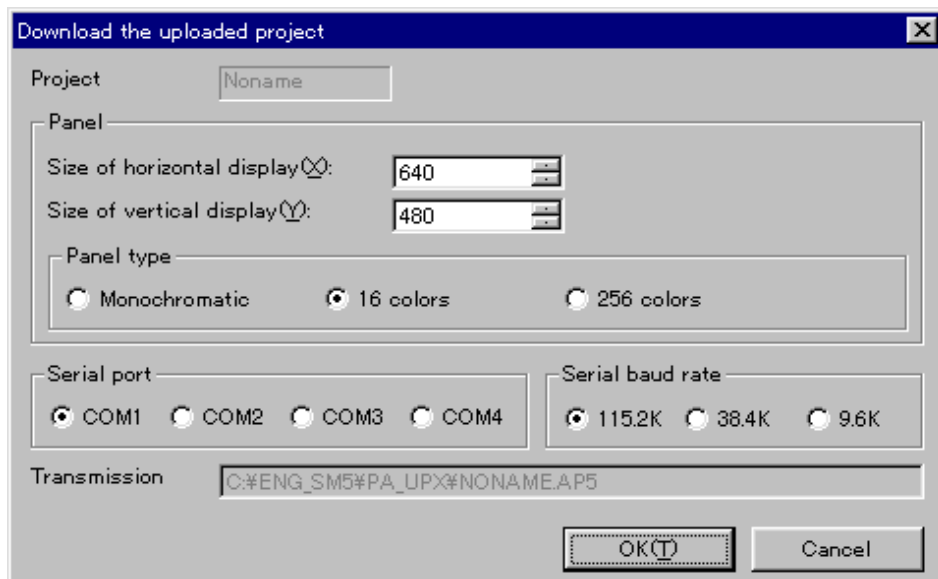

- ◇ Project
Project name is fixed to "Noname".
- ◇ Panel/Size of horizontal display (X)
Select a resolution for the connected panel indicator in the longitudinal direction.
- ◇ Panel/Size of vertical display (Y)
Select a resolution for the connected panel indicator in the latitudinal direction.
- ◇ Panel/Panel type
Select the type of an indicator in the panel connected to your computer.
- ◇ Serial port
Select the number of a serial port to be connected.
- ◇ Serial baud rate
Select a transfer rate of the serial port to be connected.
- ◇ Transmission
The file name is fixed to NONAME.AP5 in the PA_UPX folder. You cannot change the name.



- If you want to download preserved uploaded data, copy the preserved one (copied NONAME.AP5) to the PA_UPX folder and execute [Download the uploaded project].



- The upper limit of communication speed (RS232C) depends on how fast your computer is. The maximum transfer rate of Screen Creator 5 is 115.2 KB/sec. If your computer does not support the speed, lower the transfer rate.

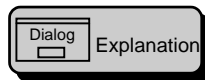

[Upload/Download]

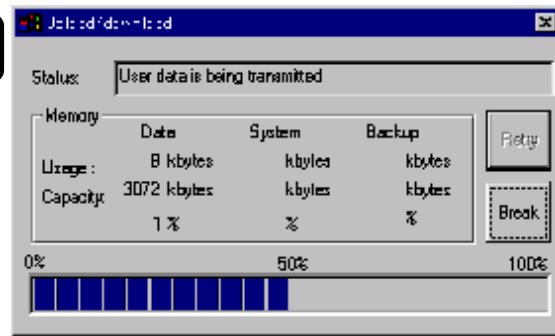

- ◇ **Status**
Displays progressing status of downloading. If an error occurs, its contents are displayed.
- ◇ **Memory**
Displays used amount of data memory as well as the OIP capacity and its use rate. No display is performed for the system memory and backup memory.
- ◇ **Progress bar**
This bar graph displays the current rate of download data amount.
- ◇ **Retry**
This button is for re-transferring data.
- ◇ **End**
This button is for termination of data transfer and closing the window.

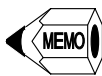

- The Upload/Download is not a dialog but a window. Accordingly, you can use Screen Creator 5 during uploading. Note that two or more Upload/Download cannot be started.



- If a communication error occurs during uploading, you have possibly set a communication speed higher than that your computer supports. Check the upper limit of the communication speed of your computer and set Screen Creator 5 whose maximum speed must be lower than that of your computer.

(9) New Text (S)

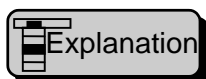

This function is designed for creating a character string to be used in the project. The created character string can be displayed with a character indicator.



Select a menu to open a dialog.

For new creation, enter a character string in the editor and click on the [Save] button. When the Save dialog is opened, name the character string and execute the save function.

To edit an existing character string, click on the [Open] button to open a dialog and select an existing character string name. (Refer to the [Open a character string] dialog). When a character string is loaded into the editor, you can edit it and save it, likewise you create a character string.

Click on the [OK] button to end the operation.

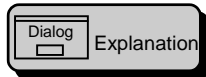

[New Text]

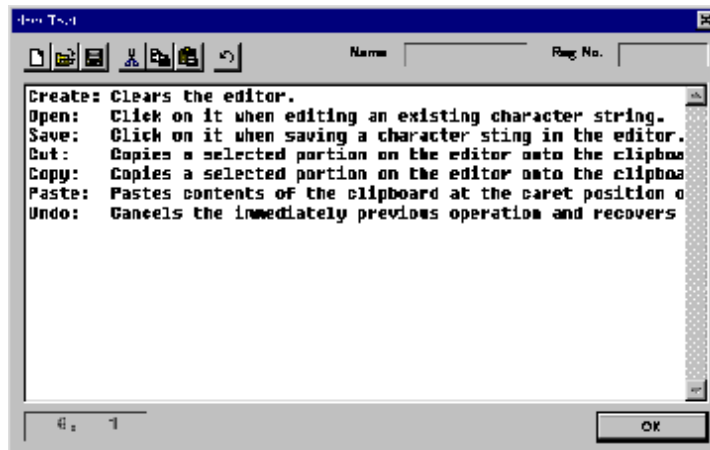

◇ Buttons (arranged on the top of the editor)

The buttons offer tool bar functions; they are described below from the left of the bar.

New: Clears the editor.

Open: Click on it when editing an existing character string.

Save: Click on it when saving a character sting in the editor.

Cut: Copies a selected portion on the editor onto the clipboard and erases it.

Copy: Copies a selected portion on the editor onto the clipboard.

Paste: Pastes contents of the clipboard at the caret position on the editor.

Undo: Cancels the immediately previous operation and recovers the original state.

◇ Name

A character string name appears on the editor. For new creation, nothing is displayed.

◇ Reg No.

The recorded number of a character string appears on the editor. For new creation, nothing is displayed.

◇ Editor

Enters a character string.



- A character string consists of up to 8000 alphanumeric. This is no limitation on the number of lines returned.
- Up to 1024 character strings are allowed.
- When you right-click on the editor, a context menu appears.



- The Undo function is effective only for the last action (limited to the immediately previous operation).
- No Tab can be inserted in a character string.

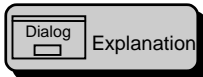

[Open Text]

This is a sub-dialog of the character string creation dialog. On this dialog, you can select a character string to be open.

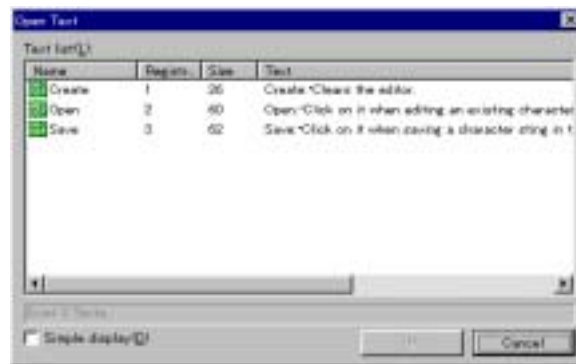

- ◇ Text list (L)
A list of existing character strings appears.
- ◇ Simple display (D)
Marking this check box causes a list of only character string names to appear.
Thus more names can be displayed.

To select a character string, click on a character string name to display it in the reverse image. Then click on the [OK] button. You may select it with double click.

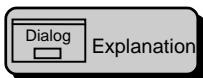

[Save Text]

This is a sub-dialog of the character string creation dialog. On this dialog, you can save a character string to be open.

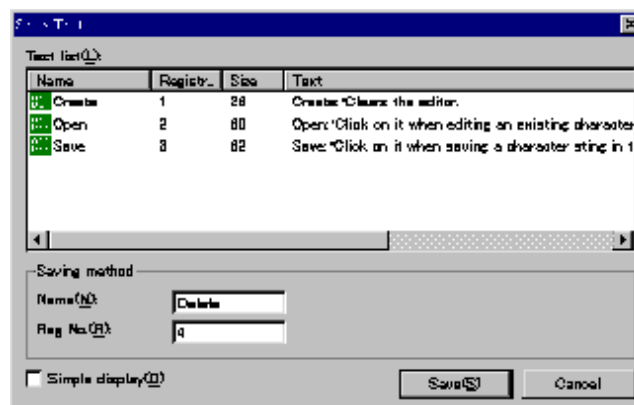

- ◇ Text list (L)
A list of existing character strings appears.
- ◇ Simple display (D)
Marking this check box causes a list of only character string names to appear.
Thus more names can be displayed.
- ◇ Saving method/Name (N)
Enter a character string name with up to eight alphanumeric.
- ◇ Saving method/Reg No. (R)
When you enter a number here, it is assigned to a character string automatically.
Thus you can omit the recording operation.

(10) Edit device (M)

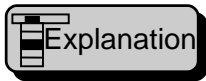

Explanation

This function displays a list of connected PLCs. In addition, you can change a device address when using the editing function.

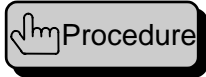

Procedure

The [Edit device] dialog box is opened.
 If you want to select displaying devices further, click on the [Squeeze] button to open the [Squeeze devices] dialog box.
 Select a device to be edited.
 Change the device name.
 When having finished editing for all devices, click on the [OK] button.

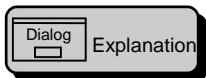

[Edit device]

Displays names of controls that are used in action parameters. (A blank means that the device is used in a program.)

Displays component names in use.

Displays a screen name in use.

Displays device names.

Displays which operation, read or write, is being performed.

Displays which communication, cyclic or event, is being performed.

Displays the number of devices being used at the same time.

Device	Screen	Parts	Control	R/W	E/C	Continuous	
00^X0000	08_01	B000		Write	Event	1	
00^X0000	08_01	B000		Read	Cyclic	1	
00^X0000	08_01	B001		Read	Event	1	
00^X0003	08_01	B002		Write	Event	1	
00^X0003	08_01	B002		Read	Cyclic	1	
00^X0008	08_01	B003		Read	Event	1	
00^X0007	08_01	B004		Write	Event	1	
00^X0007	08_01	B004		Read	Cyclic	1	
00^X0007	08_01	B006		Read	Event	1	
00^Y0010	08_01	B006		Write	Event	1	
00^Y0010	08_01	B006		Read	Cyclic	1	
00^Y0010	08_01	B007		Read	Event	1	
00^Y001 E	08_01	B008		Write	Event	1	
00^Y001 E	08_01	B008		Read	Cyclic	1	
00^Y001 E	08_01	B008		Read	Event	1	
00^Y001 F	08_01	B010		Write	Event	1	
00^Y001 F	08_01	B010		Read	Cyclic	1	
00^Y001 F	08_01	B011		Read	Event	1	

1000 devices was defined, 8004 devices have been used.

Buttons: Squeeze(S), Change(C), Replace(R), Addition(A), OK(O), Cancel

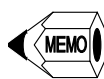

- Clicking on the [Device list] button causes the devices to be sorted in the alphabetic order.
- ◇ Squeeze (S)
Further selects devices to be displayed on the [Device list] screen.
- ◇ Change (C)
Changes a device name selected on the [Device list] screen.
- ◇ Replace (R)
Replaces devices selected on the [Device list] screen at a time.
- ◇ Addition (A)
Applies an operation (add/subtract) to a device number on the [Device List] screen.

- ◇ OK (E)
Execute the resultant of the editing on the [List devices] screen.
- ◇ Cancel
Closes the [Edit a device] dialog box. The resultant of the editing is made invalid.

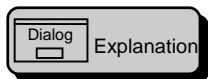

[Squeeze device]

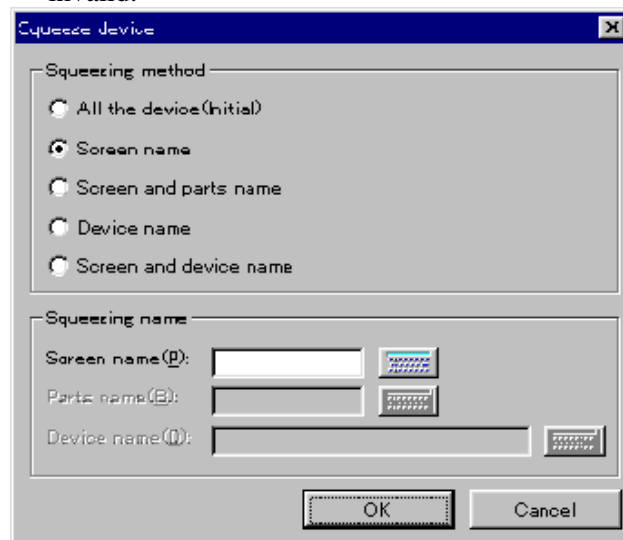

- ◇ Squeeze method/All the device (Initial)
Displays all devices on the [Device list] screen.
- ◇ Squeeze method/Screen name
Displays devices on the specified screen on the [Device list] screen.
- ◇ Squeeze method/Screen and parts name
Displays devices used in components on the specified screen on the [Device list] screen.
- ◇ Squeeze method/Device name
Displays a device agreeing with a specified device name on the [Device list] screen.
- ◇ Squeeze method/Screen and device name
Displays a device agreeing with a specified device name on the specified screen the [Device list] screen.
- ◇ Squeezing name/Screen name (P)
Specify a screen name with which selection is to be performed.
- ◇ Squeezing name/Parts name (B)
Specify a component name with which selection is to be performed.
- ◇ Squeezing name/Device name (D)
Specify a device name with which selection is to be performed.
- When selection is performed with a screen name, component name, or device name, the item having the same character string with the specified name from the top is selected.



(11) Backup (B)

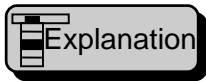

This function is to back up the system. The backup is a safety measure for recovering the system to the point where the system was saved if any trouble occurs. It is extremely difficult to recover the system of complex projects that usually have a huge volume of screens. Thus users are recommended to save the system periodically.

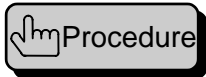

Select a menu to open a dialog.
 Enter the name of a folder where backup data is saved. You must have allocated the folder. (In general, the folder should be a root folder. For example, A:¥.)
 Clicking on the [OK] button starts the backup operation and a message in progress to appear.
 When the resultant message appears, click on the [Cancel] button.

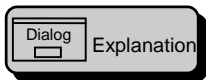

[Mark backup of project]

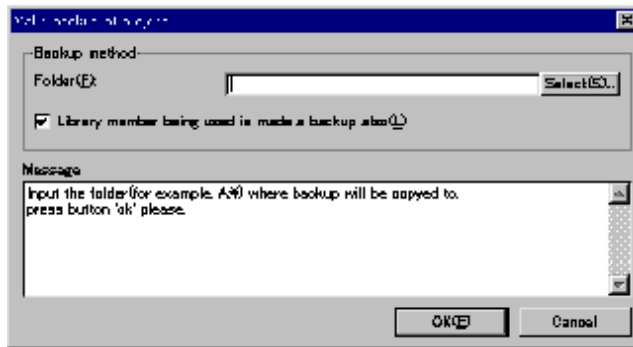

- ◇ Backup method/Folder (F)
 Enter the name of a path where backup data is stored. For example, the path name for a floppy disk is A:¥.
- ◇ Backup method/Select (S)
 Open a selection dialog and enter a destination folder for the back up directly.
- ◇ Backup method/Library member being used is mode a backup also (L)
 When this check box is marked, a library file in use is also backed up. To make this function effective, downloading data must have been generated correctly.
- ◇ Message
 A message in progress or result appears.

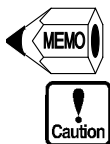

- The backup result is displayed in the reverse image.
- The size of the backup destination must be larger than a total size of project folders. Suppose that you are using removable storage (such as floppy disks), a medium change message appears when a medium becomes full. Then follow the message for exchanging media.

(12) Restore (A)

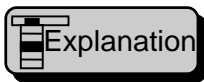

Explanation

This function is intended to restore the backed up project. It is a safety measure for recovering the system to the point where the system was saved if any trouble occurs.

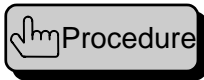

Procedure

Select a menu to open a dialog.

Enter the name of a project to be restored. The name must have been backed up project name.

Clicking on the [OK] button starts the restore operation and a message in progress to appear.

When the resultant message appears, click on the [Cancel] button.

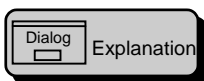

Dialog Explanation

[Restore project]

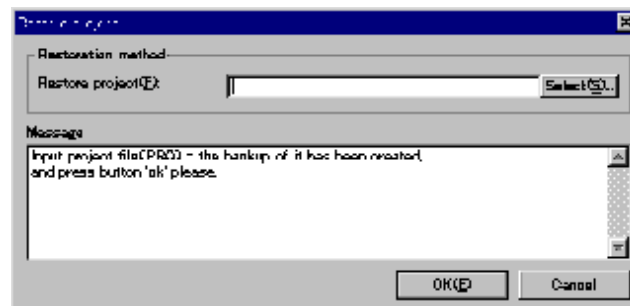

◇ Restoration method/Restore project (F)

Enter the name of a project file in a backup medium, such as a floppy disk.

◇ Restoration method/Select (S)

Open a selection dialog and enter a project file name.

◇ Message

A message in progress or result appears.



- The restore result is displayed in the reverse image.
- When a backed up screen or library is listed, the current one is replaced with the backed up one. Thus, the replaced one may be older than the current one. When generating a downloading object, specify the [Recompile all screens] function.

(13) Copy (Y)

This function is to copy a project.

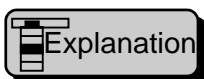

Explanation



Procedure

Select a menu to open a dialog.

Enter the name of a source project. The name must be an existing project name. The default is the currently opened one.

Enter the name of a destination project. The name must not be duplicated with an existing one.

Click on the [OK] button.



[Copy project]

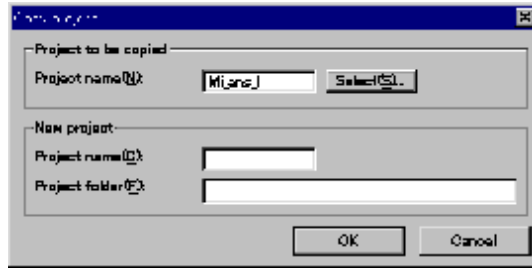

- ◇ Project to be copied/Project name (N)
Enter the name of a project you want to copy.
- ◇ Project to be copied/Select (S)
Open a selection dialog and enter a source project name directly. The default value is the currently opened project name.
- ◇ New project/Project name (C)
Enter the name of a new project (copied one).
- ◇ New project/Project folder (F)
Enter the name of a folder accommodating a new project. Entering a project name causes the default to be input.



- You cannot specify an existing project for the destination.

(14) Delete (E)

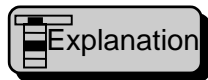

This function is to delete a project. You cannot delete a currently opened project.

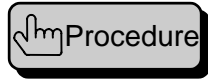

- Select a menu to open a dialog.
- Enter a project name.
- Click on the [OK] button.

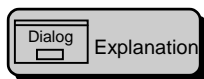

[Delete a project]

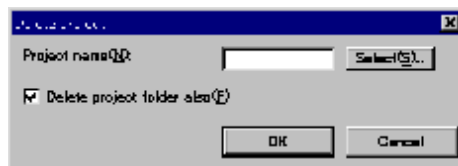

- ◇ Project name (N)
Enter the name of a project you want to delete.
- ◇ Select (S)
Open a dialog and enter a project name directly.
- ◇ Delete project folder also
Marking this check box deletes the folder accommodating the project file.



- You cannot delete a currently opened project.
- You cannot restore a project once deleted. It is recommended that the project be backed up before deletion.